

Home & Life

Kitchen Furniture

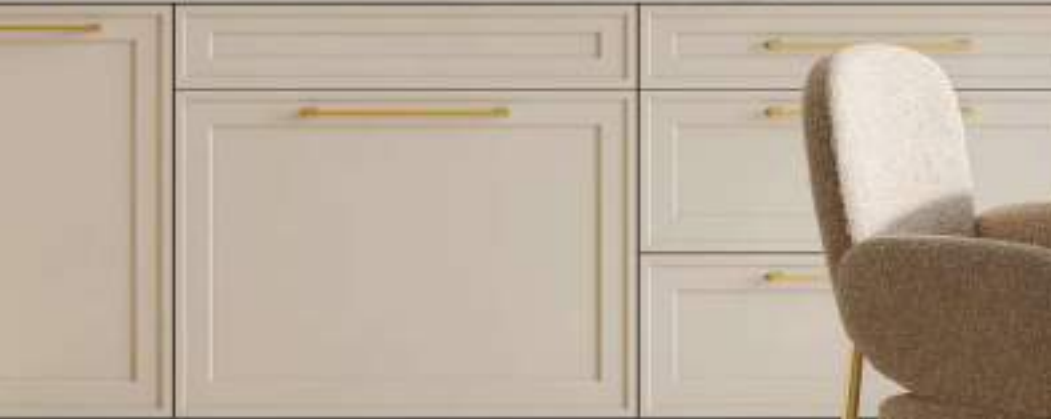

STOLKAR

SINCE 1989





STOLKAR

O firmie

About company



Fabryka Mebli STOLKAR założona została przez Wojciecha Wiśniewskiego w 1989 roku w Brodnicy. Od początku istnienia domeną naszej działalności była produkcja mebli kuchennych oraz łazienkowych. Posiadamy nowoczesny park maszynowy producentów niemieckich, w większości firmy HOMAG, znajdujący się w halach produkcyjnych o powierzchni ponad 6000 m². Wszystkie elementy mebli od korpusów po fronty lakierowane, wytwarzamy we własnym zakresie, dzięki czemu nasi Klienci otrzymują pewne produkty w możliwie najkrótszym czasie. W procesie produkcyjnym wykorzystujemy maszyny sterowane cyfrowo, co zapewnia wysoką precyzję, jakość wykonania oraz trwałość na lata.

W ofercie Fabryki Mebli STOLKAR znajdziecie Państwo szeroki wachlarz produktów. Specjalizujemy się w tworzeniu prestiżowych mebli kuchennych na wymiar, ale w naszej ofercie nie brakuje mebli dla osób ceniących modułowość i możliwość samodzielnej aranżacji przestrzeni. Tworzymy kompleksowe rozwiązania dla klientów biznesowych. Współpracujemy z architektami oraz deweloperami - realizujemy zlecenia pod indywidualne inwestycje. Tworzymy wyjątkowe produkty i wierzymy, że dzięki nim wnętrza naszych klientów zyskają niepowtarzalny charakter oraz wyjątkowy klimat. Ze względu na wysoką jakość wykonania, nasze meble są doceniane przez klientów na całym świecie. Mamy nadzieję, że Państwo również dołączą do grona naszych zadowolonych klientów.

The STOLKAR Furniture Factory was founded by Wojciech Wiśniewski in 1989 in Brodnica. From the beginning, the domain of our activity was the production of kitchen and bathroom furniture. We have a modern machine park of German manufacturers, mostly HOMAG, located in production halls with an area of over 6,000 m². All furniture elements, from bodies to varnished fronts, are manufactured in-house, thanks to which our customers receive reliable products in the shortest possible time. In the production process, we use digitally controlled machines, which ensures high precision, quality and durability for years.

The STOLKAR Furniture Factory offer includes a wide range of products. We specialize in creating prestigious custom-made kitchen furniture, but our offer also includes furniture for people who value modularity and the ability to arrange space on their own. We create comprehensive solutions for business clients. We work with architects and developers - we carry out orders for individual investments. We create unique products and we believe that thanks to them our customer's interiors will gain a unique character and a unique atmosphere. Due to the high quality of workmanship, our furniture is appreciated by customers around the world. We hope that you will also join group of our satisfied customers.

Spis treści

Table of contents

PREMIUM LINE KUCHNIE NOWOCZESNE Modern kitchens



NOWOŚĆ

10



ALVICO

12



GOYA

14



NAOMI

16



NINA

18



OLIWIA

20



POLA

22

Kolorystyka / colors.....	52
Dostępne szafki / Available cabinets.....	57
Błaty / worktops.....	117
Uchwyty / handles.....	118

PREMIUM LINE KUCHNIE KLASYCZNE Classic kitchens



ALINA LAKIER

26



ALINA FOLIA

28



ANNA LAKIER

30



ANNA FOLIA

32



ALICJA LAKIER

34



ALICJA FOLIA

36



DAFNE LAKIER

38



DAFNE FOLIA

40



GRACE

42



LILIANA LAKIER

44



LILIANA FOLIA

46



MONIUSZKO

48

Kolorystyka / colors.....	52
Dostępne szafki / Available cabinets.....	57
Błaty / worktops.....	117
Uchwyty / handles.....	118

TREND LINE



NOWOŚĆ

66



ADELE

68



BONO

70



DENIS

72



EMILY

74



IRMA

76



KATE

78



LIVIA

80



MAX

82



OSCAR

84



TRACY

86



ZOYA

88

Kolorystyka / colors..... 90
Dostępne szafki / Available cabinets..... 92
Wyspy kuchenne / Kitchen islands..... 94

Blaty / worktops..... 117
Uchwyty / handles..... 118

CLASSIC LINE



VERA

100



NATALIA

102



VITA

104



CLARA

106



EMMA

108



ELENA

110

ECO LINE



MELA

112

Dostępne szafki / Available cabinets..... 114
Blaty / worktops..... 117
Uchwyty / handles..... 118

Aksesoria dodatkowe / additional accessories... 120
Zlewozmywaki / sinks..... 123



PREMIUM LINE

KUCHNIE NOWOCZESNE
MODERN KITCHENS



ALVICO
GOYA
NAOMI
NINA
OLIWIA
POLA

S PREMIUM *line*

PREMIUM LINE jest to system mebli kuchennych opracowany z myślą o najbardziej wymagających klientach, poszukujących trwałych, spersonalizowanych i funkcjonalnych rozwiązań oraz oryginalnego wzornictwa.

PREMIUM LINE to nasza odpowiedź na Twoje marzenia o idealnej kuchni.

PREMIUM LINE is a kitchen furniture system developed for the most demanding customers looking for solid, personalized and functional solutions and original design. The **PREMIUM LINE** is our answer to your dreams about an ideal kitchen.



JAK TYLKO ZAMARZYSZ

W naszej ofercie znajdują Państwo 13 wzorów frontów dostępnych w ponad 70 wybarwieniach, które powinny urzeczywistnić marzenia o idealnej kuchni nawet najbardziej wymagających Klientów.

JUST AS IN YOUR DREAMS

The first impression is made by the cabinet fronts. Our offer comprises 13 front patterns available in over 70 colors to make the dreams of an ideal kitchen come true for even the most demanding customers.



SWOBODA WYBORU

Odpowiednio dobrany uchwyt jest jak biżuteria - nadaje wnętrzu niepowtarzalny charakter. Oferujemy Państwu 48 wzorów uchwytów dostępnych w kilku długościach.

THE FREEDOM OF CHOICE

Properly selected handles and knobs are like jewellery - they give a unique character to the interior. Our offer includes 48 various handles available in several lengths.



NIEOGRANICZONY DOSTĘP

Zastosowane we frontach uchylnych podnośniki z możliwością pozycjonowania gwarantują łatwy dostęp do wnętrza szafek oraz swobodę ruchu podczas pracy w kuchni.

UNLIMITED ACCESS

The springs mounted in swivel fronts provide an easy access to the cabinet interior and freedom of movements during work in the kitchen.



FUNKCJONALNOŚĆ W STANDARDZIE

Wyjątkowa głębokość szafek dolnych (524 mm) oraz szuflad (500 mm) pozwalają zaoszczędzić oraz funkcjonalnie wykorzystać dostępną w kuchni przestrzeń.

FUNCTIONALITY AS A STANDARD

The exceptional depth of lower cabinets (524 mm) and drawers (500 mm) allow for the saving of the kitchen space and making a functional use of it.

CISZA W KUCHNI

Zawiasy oraz szuflady wyposażone w system cichego zamykania gwarantują delikatne zamykanie i otwieranie frontów.

SILENCE IN THE KITCHEN

The hinges and drawers are equipped with the soft closing system to make the front open and shut in a delicate manner.



DO ZADAŃ SPECJALNYCH

Meble w kuchni to nie wszystko. Oferujemy Państwu praktyczne akcesoria, które nie tylko umilą czas spędzany podczas przygotowywania posiłków, ale również sprawią, że praca w kuchni będzie czystą przyjemnością.

SPECIAL TASKS

The furniture is not everything in the kitchen. Our practical accessories will make your time spent on preparing food more pleasant and satisfactory.



DLA MAŁYCH I DUŻYCH

Nóżki z możliwością regulacji pozwalają na stabilne ustawienie mebla nawet na nierównej powierzchni. Nóżki dostępne w 2 wysokościach (100 mm, 150 mm).

FOR THE SHORT AND THE TALL

Adjusted legs make the furniture stand stable on uneven surfaces. The legs are available in various sizes (100 mm, 150 mm) to provide more adjustment possibilities.



TWORZYMY KUCHNIE NA WYMIAR

Ogromny wybór szafek sprawia, że Twoja kuchnia stanie się miejscem funkcjonalnym i dopasowanym do danej przestrzeni. Mamy dla Państwa do wyboru ponad 250 szafek, a możliwość ich modyfikacji z pewnością ułatwi wykreować wymarzony układ kuchni.

WE CREATE CUSTOM KITCHENS

The vast range of cabinets makes your kitchen a functional space, well adapted to its surface. We have over 250 cabinets to choose from, and the ability to modify them will certainly help you create your dream kitchen layout.



NAJWYŻSZA JAKOŚĆ

Wygoda, estetyka i jakość na lata to cechy definiujące okucia marki BLUM®. Oferujemy możliwość zakupu szafek z szufladami MERIVOX oraz podnośnikami AVENTOS. Wykaz dostępnych brył na stronie 61.

HIGHEST QUALITY

Convenience, aesthetics and quality for years are the defining features of BLUM® fittings. We offer the possibility of purchasing cabinets with MERIVOX drawers and AVENTOS lifts. List of available solids on page 61.



NOWOŚĆ

Rozwiązania dla osób z niepełnosprawnościami ruchowymi.

- Najważniejsze sprzęty i akcesoria kuchenne w zasięgu ręki.
- Dostępna pełna kolorystyka kolekcji Premium line oraz Trend line.
- Możliwość zastosowania okuć marki Blum®.

dostępna kolorystyka frontów, korpusów, blatów s. **52-56, 117**
wykaz dostępnych szafek s. **57-61**

Solutions for people with mobility disabilities.

- The most important kitchen appliances and accessories at your fingertips.
- Full colors of the Premium line and Trend line collections available.
- The possibility of using Blum® fittings.

available colors of fronts, cabinets, worktops p. **52-56, 117**
specification of available cabinets p. **57-61**



wysoki połysk & mat
high gloss & mat



dostępne inne
wybarwienia
other colors available

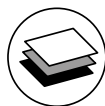

blat do wyboru
worktop to
choose from

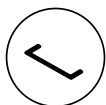

metalowy uchwyt
metal handle

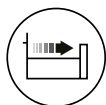

szuflada pełen wysuw
ciche domykanie
full extension drawer
soft closing



ciche domykanie frontów
softclose system

Kolekcja Premium line została rozbudowana o szafki zaprojektowane z myślą o potrzebach osób z niepełnosprawnościami ruchowymi. Piekarnik, zmywarka dostępne na wyciągnięcie dłoni, mobilne szafki na kółkach oraz podwieszane szafki dolne to tylko niektóre z przygotowanych udogodnień.

The Premium line collection has been expanded with cabinets designed to meet the needs of people with physical disabilities. An oven, dishwasher available at your fingertips, mobile cabinets on wheels and suspended lower cabinets are just some of the prepared amenities.





ALVICO

- Imponujący połysk frontów LUXE.
- Wyjątkowe struktury Syncrone.
- Designerskie dekory.

dostępna kolorystyka frontów, korpusów, blatów s. **52, 52, 117**
 wykaz dostępnych szafek s. **57-61**

- The imposing gloss of the fronts LUXE.
- Unique Syncrone structures.
- Designer decors.

available colors of fronts, cabinets, worktops p. **52, 52, 117**
 specification of available cabinets p. **57-61**



wysoki połysk & mat
 high gloss & mat



dostępne inne
 wybarwienia
 other colors available

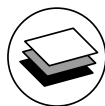

blat do wyboru
 worktop to
 choose from



metalowy uchwyt
 metal handle



szuflada pełen wysuw
 ciche domykanie
 full extension drawer
 soft closing



ciche domykanie frontów
 softclose system

ALVICO to kuchnia z płyty MDF o prostej, eleganckiej stylistyce. Niewiarygodna głębia połysku, matowa elegancja oraz wyjątkowe struktury, to cechy wyróżniające fronty Alvico na rynku.

ALVICO is a simple and elegant set of kitchen furniture made of MDF board. Incredible depth of gloss, matt elegance and unique structures are the hallmarks of the Alvico fronts on the market.







GOYA

- Lakierowane fronty MDF, dostępne w 17 wersjach kolorystycznych.
- Frezowany uchwyt z czarnego szkła.
- Ogromne możliwości indywidualnej zabudowy.

dostępna kolorystyka frontów, korpusów, blatów s. **55, 52, 117**
wykaz dostępnych szafek s. **57-61**

- Lacquered MDF fronts, available in 17 color versions.
- Milled handle of black glass.
- Huge possibilities of individual layout.

available colors of fronts, cabinets, worktops p. **55, 52, 117**
specification of available cabinets p. **57-61**



wysoki połysk & mat
high gloss & mat

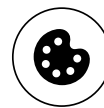

dostępne inne
wybarwienia
other colors available

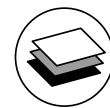

blat do wyboru
worktop to
choose from



szuflada pełen wysuw
ciche domykanie
full extension drawer
soft closing



ciche domykanie frontów
softclose system

Nowoczesne meble kuchenne Goya mają fronty wykończone w macie. Meble o prostych bryłach i dużych, gładkich powierzchniach doskonale wpisują się w aktualne trendy stylistyczne nadając kuchennym wnętrzom przestronny charakter.

Modern Goya kitchen furniture has fronts finished in gloss and mat. Furniture with simple solids and large, smooth surfaces perfectly fit into the current stylistic trends giving the kitchen interior spacious character.



NAOMI

- Aksamitnie matowa powierzchnia frontów.
- Idealna głębia kolorów.
- Kolorystyka nawiązująca do aktualnych trendów.

dostępna kolorystyka frontów, korpusów, blatów s. **53, 52, 117**
wykaz dostępnych szafek s. **57-61**

- Velvety matte surface of the fronts.
- Perfect color depth.
- Colors refer to current trends.

available colors of fronts, cabinets, worktops p. **53, 52, 117**
specification of available cabinets p. **57-61**



mat
mat

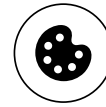

dostępne inne
wybarwienia
other colors available

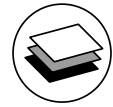

blat do wyboru
worktop to
choose from

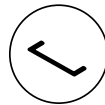

metalowy uchwyt
metal handle

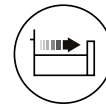

szuflada pełen wysuw
ciche domykanie
full extension drawer
soft closing



ciche domykanie frontów
softclose system

Naomi to kuchnia o kusząco matowych, aksamitnych w dotyku frontach, dostępnych w najmodniejszej kolorystyce. Idealnie gładkie powierzchnie doskonale wpiszą się w każde nowoczesne wnętrze. Ponadto, stanowią idealną bazę do wielu aranżacji.

Naomi is a kitchen with seductively matte, velvety to the touch fronts, available in the most fashionable colors. Perfectly smooth surfaces will fit perfectly into any modern interior. In addition, they are an ideal base for many arrangements.

NINA

- Lakierowane fronty MDF, dostępne w 17 wersjach kolorystycznych.
- Frezowany uchwyt.
- Pojemne górne szafki, wysokie na 92 cm.

dostępna kolorystyka frontów, korpusów, blatów s. **55, 52, 117**
wykaz dostępnych szafek s. **57-61**

- Lacquered MDF fronts, available in 17 color versions.
- Milled handle.
- Spacious upper cabinets, 92 cm high.

available colors of fronts, cabinets, worktops p. **55, 52, 117**
specification of available cabinets p. **57-61**



wysoki połysk & mat
high gloss & mat

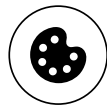

dostępne inne
wybarwienia
other colors available

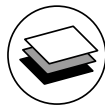

blat do wyboru
worktop to
choose from

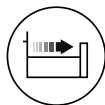

szuflada pełen wysuw
ciche domykanie
full extension drawer
soft closing



ciche domykanie frontów
softclose system

Dyscyplina form i podziałów wydobywa gładkie, niezakłócone uchwyty płaszczyzny frontów. Perfekcyjne wykończenie każdego detalu, modna kolorystyka, solidne blaty robocze i proste bryły to gotowa formuła na nowoczesną kuchnię.

The discipline of forms and divisions emphasizes the smooth surfaces of fronts, undisturbed by handles. Perfect finishing of each detail, trendy colors, and solid worktops and simple shapes are ready formula for a modern kitchen.







OLIWIA

- Możliwość tworzenia kompozycji z frontami kuchni Alvico.
- Struktury imitujące naturalne drewno.
- Fronty z obrzeżem ABS.

dostępna kolorystyka frontów, korpusów, blatów s. **53, 52, 117**
wykaz dostępnych szafek s. **57-61**

- The possibility to create compositions with Alvico kitchen fronts.
- Structures imitating natural wood.
- Fronts with ABS edge.

available colors of fronts, cabinets, worktops p. **53, 52, 117**
specification of available cabinets p. **57-61**



mat
mat

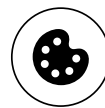

dostępne inne
wybarwienia
other colors available

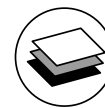

blat do wyboru
worktop to
choose from

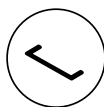

metalowy uchwyt
metal handle

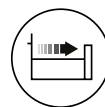

szuflada pełen wysuw
ciche domykanie
full extension drawer
soft closing



ciche domykanie frontów
softclose system

Meble kuchenne Oliwia to uniwersalna propozycja do kuchni otwartych oraz zamkniętych. Fronty wykonane z płyty laminowanej o grubości 18mm. Komfort codziennego użytkowania zapewniają nowoczesne rozwiązania konstrukcyjne oraz liczne akcesoria.

Oliwia is a universal proposition for open kitchens and closed. The fronts are made of 18mm thick laminated board. The comfort of everyday use is ensured by modern construction solutions and numerous accessories.



POLA

- Lakierowane fronty dostępne w siedemnastu kolorach.
- Gładką powierzchnię o prostych krawędziach.
- Uniwersalny design.

dostępna kolorystyka frontów, korpusów, blatów s. **55, 52, 117**
wykaz dostępnych szafek s. **57-61**

- Lacquered fronts available in seventeen colors.
- Smooth surface with straight edges.
- Universal design.

available colors of fronts, cabinets, worktops p. **55, 52, 117**
specification of available cabinets p. **57-61**



wysoki połysk & mat
high gloss & mat

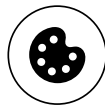

dostępne inne
wybarwienia
other colors available

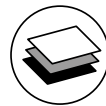

blat do wyboru
worktop to
choose from

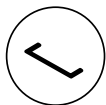

metalowy uchwyt
metal handle

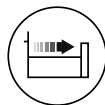

szuflada pełen wysuw
ciche domykanie
full extension drawer
soft closing



ciche domykanie frontów
softclose system

Proste bryły i duże gładkie powierzchnie frontów wpisują się w aktualne trendy wzornicze mebli kuchennych. Uniwersalny design mebli Pola sprawdza się w każdej przestrzeni: dużej i małej, zamkniętej i otwartej.

Simple structures and large and smooth surfaces of the fronts perfectly fit the present stylistic trends. The universal design of the POLA series is ideal for every space: large and small, closed and open.







PREMIUM LINE

KUCHNIE KLASYCZNE
CLASSIC KITCHENS



ALINA LAKIER
ALINA FOLIA
ANNA LAKIER
ANNA FOLIA
ALICJA LAKIER
ALICJA FOLIA
DAFNE LAKIER
DAFNE FOLIA
GRACE
LILIANA LAKIER
LILIANA FOLIA
MONIUSZKO

ALINA LAKIER

- Lakierowane fronty o matowym lub połyskowym wykończeniu.
- Zróżnicowana wysokość szafek górnych: 360, 560, 720, 920 mm.
- Niepowtarzalny design w angielskim wydaniu.

dostępna kolorystyka frontów, korpusów, blatów **s. 56, 52, 117**
wykaz dostępnych szafek **s. 57-61**

- Lacquered fronts with a matte or glossy finish.
- Various heights of upper cabinets: 360, 560, 720, 920 mm.
- Unique English design.

available colors of fronts, cabinets, worktops **p. 56, 52, 117**
specification of available cabinets **p. 57-61**



wysoki połysk & mat
high gloss & mat



dostępne inne
wybarwienia
other colors available

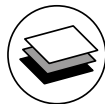

blat do wyboru
worktop to
choose from



metalowy uchwyt
metal handle

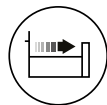

szuflada pełen wysuw
ciche domykanie
full extension drawer
soft closing



ciche domykanie frontów
softclose system

Meble kuchenne Alina to klasyczny wzór w angielskim stylu, który nigdy nie wychodzi z mody. Doskonałe proporcje i perfekcyjne wykończenie każdego detalu to podstawowe cechy kolekcji Alina. Szafki i szuflady o zróżnicowanym kształcie, praktyczne półki i małe szufladki zostały stworzone z myślą o komforcie i wygodzie.

The ALINA series shows a classical English style that will never become unfashionable. Perfect proportions and finishing of each detail are the basic properties of the series. The cabinets and drawers of various shapes, practical shelves and small drawers are designed for the user comfort.







ALINA FOLIA

- Elementy zdobnicze typu listwy ozdobne.
- Zróżnicowana wysokość szafek górnych: 360, 560, 720, 920 mm.
- Niepowtarzalny design w angielskim wydaniu.

dostępna kolorystyka frontów, korpusów, blatów s. **56, 52, 117**
wykaz dostępnych szafek s. **57-61**

- Decorative elements, such as strips.
- Various heights of upper cabinets: 360, 560, 720, 920 mm.
- Unique english design.

available colors of fronts, cabinets, worktops p. **56, 52, 117**
specification of available cabinets p. **57-61**



mat
mat



dostępne inne
wybarwienia
other colors available

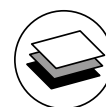

blat do wyboru
worktop to
choose from

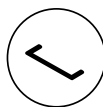

metalowy uchwyt
metal handle

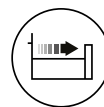

szuflada pełen wysuw
ciche domykanie
full extension drawer
soft closing



ciche domykanie frontów
softclose system

Meble kuchenne Alina to klasyczny wzór w angielskim stylu, który nigdy nie wychodzi z mody. Doskonałe proporcje i perfekcyjne wykończenie każdego detalu to podstawowe cechy kolekcji Alina. Szafki i szuflady o zróżnicowanym kształcie, praktyczne półki i małe szufladki zostały stworzone z myślą o komforcie i wygodzie.

The ALINA series shows a classical English style that will never become unfashionable. Perfect proportions and finishing of each detail are the basic properties of the series. The cabinets and drawers of various shapes, practical shelves and small drawers are designed for the user comfort.



ANNA LAKIER

- Frezowane lakierowane fronty MDF.
- Ciepła kolorystyka.
- Tradycyjne wzornictwo.

dostępna kolorystyka frontów, korpusów, blatów s. **56, 52, 117**
wykaz dostępnych szafek s. **57-61**

- Milled lacquered MDF fronts.
- Warm colors.
- Traditional design.

available colors of fronts, cabinets, worktops p. **56, 52, 117**
specification of available cabinets p. **57-61**



wysoki połysk & mat
high gloss & mat

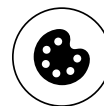

dostępne inne
wybarwienia
other colors available

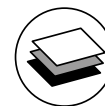

blat do wyboru
worktop to
choose from

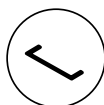

metalowy uchwyt
metal handle

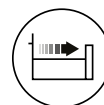

szuflada pełen wysuw
ciche domykanie
full extension drawer
soft closing



ciche domykanie frontów
softclose system

Meble kuchenne w klasycznym wydaniu. Stworzone dla miłośników tradycyjnych wnętrz, stanowią kombinację wyszukanego stylu i maksymalnej funkcjonalności. Głęboko frezowane fronty i złote uchwyty tworzą spójną ponadczasową całość.

Classical kitchen furniture for the lovers of traditional interiors. The series combines sophisticated style with maximum functionality. Deeply milled fronts and golden handles create a coherent and timeless entirety.



ANNA FOLIA

- Frezowane foliowane fronty MDF.
- Ozdobne listwy.
- Tradycyjne wzornictwo.

dostępna kolorystyka frontów, korpusów, blatów s. **56, 52, 117**
wykaz dostępnych szafek s. **57-61**

- Milled foiled MDF fronts.
- Decorative strips.
- Traditional design.

available colors of fronts, cabinets, worktops p. **56, 52, 117**
specification of available cabinets p. **57-61**



mat
mat



dostępne inne
wybarwienia
other colors available

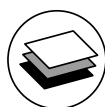

blat do wyboru
worktop to
choose from



metalowy uchwyt
metal handle

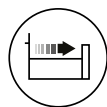

szuflada pełen wysuw
ciche domykanie
full extension drawer
soft closing



ciche domykanie frontów
softclose system

Idealna propozycja dla osób poszukujących klasycznego piękna. Przyciągające wzrok efekty stylistyczne mebli kuchennych ANNA kryją przyjazne i funkcjonalne rozwiązania. Ciepła kolorystyka frezowanych frontów wprowadza atmosferę spokoju i przytulności.

An ideal proposal for customers seeking the classical beauty. Attracting stylistic effects of the ANNA series reveal friendly and functional solutions. The warm colors of milled fronts creates an atmosphere of calmness and cosiness.







ALICJA LAKIER

- Ogromne możliwości tworzenia indywidualnej zabudowy.
- Elegancki design.
- Lakierowane fronty MDF o grubości 19 mm.

dostępna kolorystyka frontów, korpusów, blatów s. **54, 52, 117**
wykaz dostępnych szafek s. **57-61**

- Huge possibilities of creating individual buildings.
- Elegant design.
- Lacquered MDF fronts, 19 mm thick.

available colors of fronts, cabinets, worktops p. **54, 52, 117**
specification of available cabinets p. **57-61**



mat
mat

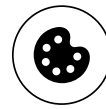

dostępne inne
wybarwienia
other colors available

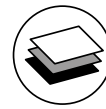

blat do wyboru
worktop to
choose from

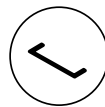

metalowy uchwyt
metal handle

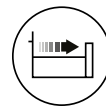

szuflada pełen wysuw
ciche domykanie
full extension drawer
soft closing



ciche domykanie frontów
softclose system

Współczesna kuchnia stanowi serce każdego domu, centralny punkt rodzinnych spotkań, przyjazną przestrzeń dla grona przyjaciół i znajomych. Meble kuchenne Alicja to propozycja dla wszystkich, którzy cenią sobie klasyczną elegancję, wygodę i indywidualny styl.

Nowadays a modern kitchen is the heart of each home, the central point of family meetings, and a friendly space for the friends and colleagues. The Alicja kitchen furniture is an offer for all who value classic elegance, comfort and individual style.

ALICJA FOLIA

- Prosta forma frezowanych frontów.
- Uniwersalny charakter.
- Foliowane fronty MDF o grubości 19 mm.

dostępna kolorystyka frontów, korpusów, blatów s. **56, 52, 117**
wykaz dostępnych szafek s. **57-61**

- The simple form of milled fronts.
- Universal character.
- 19 mm foiled MDF fronts.

available colors of fronts, cabinets, worktops p. **56, 52, 117**
specification of available cabinets p. **57-61**



mat
mat

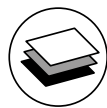

blat do wyboru
worktop to
choose from

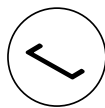

metalowy uchwyt
metal handle



szuflada pełen wysuw
ciche domykanie
full extension drawer
soft closing



ciche domykanie frontów
softclose system

Trwałość, funkcjonalność i wygoda. Ujmująca elegancja i prosta forma. To elementy, które charakteryzują meble kuchenne Alicja. Zaprojektowane na potrzeby ludzi poszukujących piękna i wygody na codzień.

Durability, functionality and comfort. Charming elegance and simple form. All these characterize the Alicja kitchen series. Designed for those who seek beauty and comfort in their everyday lives.







DAFNE LAKIER

- Lakierowane fronty MDF 19 mm, dostępne w 11 wersjach kolorystycznych.
- Subtelny wzór z delikatną ramką.
- Możliwość tworzenia ciekawych aranżacji z innymi frontami.

dostępna kolorystyka frontów, korpusów, blatów s. **54, 52, 117**
wykaz dostępnych szafek s. **57-61**

- Lacquered MDF fronts 19 mm, available in 11 colors.
- Subtle pattern with a delicate frame.
- The ability to create interesting arrangements with other fronts.

available colors of fronts, cabinets, worktops p. **54, 52, 117**
specification of available cabinets p. **57-61**



mat
mat

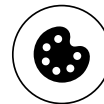

dostępne inne
wybarwienia
other colors available

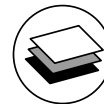

blat do wyboru
worktop to
choose from

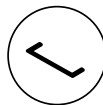

metalowy uchwyt
metal handle

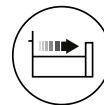

szuflada pełen wysuw
ciche domykanie
full extension drawer
soft closing



ciche domykanie frontów
softclose system

Nowoczesna klasyka w najlepszym wydaniu. Dafne, kuchnia którą pokochali projektanci już teraz dostępna również w wersji z frontami lakierowanymi. Szlachetne wykończenie w satynowym macie celnie trafi w gusta nawet najbardziej wymagających Klientów.

A modern classic at its best. Dafne, a kitchen loved by designers, is now also available in a version with varnished fronts. The noble finish in a satin mat will suit the tastes of even the most demanding customers.



DAFNE FOLIA

- Dekoracyjne foliowane fronty MDF.
- Eleganckie wzornictwo w nowoczesnym wydaniu.
- Możliwość tworzenia indywidualnej zabudowy.

dostępna kolorystyka frontów, korpusów, blatów **s. 56, 52, 117**
wykaz dostępnych szafek **s. 57-61**

- Decorative foiled MDF fronts.
- Elegant design with a modern twist.
- The possibility of creating individual buildings.

available colors of fronts, cabinets, worktops **p. 56, 52, 117**
specification of available cabinets **p. 57-61**



mat
mat



dostępne inne
wybarwienia
other colors available

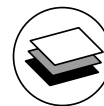

blat do wyboru
worktop to
choose from

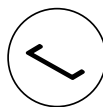

metalowy uchwyt
metal handle

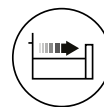

szuflada pełen wysuw
ciche domykanie
full extension drawer
soft closing



ciche domykanie frontów
softclose system

Kuchnia nowoczesna nie musi być minimalistyczna czy industrialna. Może być również elegancka i szykowna. Jeśli zależy Wam, by Wasze wnętrza były zgodne z najnowszymi trendami wzorniczymi, ale wcale nie macie ochoty rezygnować z klasycznych, ponadczasowych rozwiązań, wówczas meble kuchenne Dafne to wybór idealny.

Modern kitchen does not have to be minimalist or industrial. It can also be elegant and chic. If you want your interiors to be in line with the latest design trends, but you do not want to give up classic, timeless solutions, then Dafne kitchen furniture is the perfect choice.



GRACE

- Kuchnia inspirowana stylem retro.
- Lakierowane fronty o matowym wykończeniu.
- W szafkach przeszklonych, tylne ściany w kolorze frontów.

dostępna kolorystyka frontów, korpusów, blatów **p. 54, 52, 117**
wykaz dostępnych szafek **s. 57-61**

- Kitchen inspired by retro style.
- Lacquered fronts with a matte finish.
- In glass cabinets, rear walls in the same color as the fronts.

available colors of fronts, cabinets, worktops **p. 54, 52, 117**
specification of available cabinets **p. 57-61**



mat
mat



dostępne inne
wybarwienia
other colors available

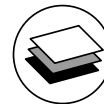

blat do wyboru
worktop to
choose from



metalowy uchwyt
metal handle

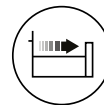

szuflada pełen wysuw
ciche domykanie
full extension drawer
soft closing



ciche domykanie frontów
softclose system

Inspirowana stylistyką retro kuchnia o subtelnie ryflowanych lakierowanych frontach. Doskonale łączy magię klasycznej elegancji z nurtem nowoczesności. Delikatne frezy interesująco urozmaicają jednobarwne matowe powierzchnie.

A retro-inspired kitchen with subtly grooved, varnished fronts. It perfectly combines the magic of classic elegance with the trend of modernity. Delicate milling cutters interestingly diversify single-color matte surfaces.



LILIANA LAKIER

- Lakierowane fronty MDF 19 mm, dostępne w 11 wersjach kolorystycznych.
- Dekoracyjny ramiakowy front.
- Ogromne możliwości indywidualnej zabudowy.

dostępna kolorystyka frontów, korpusów, blatów s. **54, 52, 117**
wykaz dostępnych szafek s. **57-61**

- Lacquered MDF fronts 19 mm, available in 17 color versions.
- Decorative framed front.
- Huge possibilities of individual layout.

available colors of fronts, cabinets, worktops p. **54, 52, 117**
specification of available cabinets p. **57-61**



mat
mat

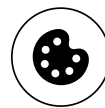

dostępne inne
wybarwienia
other colors available

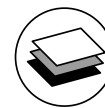

blat do wyboru
worktop to
choose from



metalowy uchwyt
metal handle

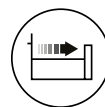

szuflada pełen wysuw
ciche domykanie
full extension drawer
soft closing



ciche domykanie frontów
softclose system

Sekret uroku kuchni Liliana tkwi w prostocie i skromnej elegancji, które są cechami charakterystycznymi tej kolekcji. Proste linie, przemyślany układ szafek oraz solidne fronty z pewnością będą służyły i zachwycaly swym urokiem przez długie lata.

The secret of Liliana's kitchen charm lies in the simplicity and modest elegance that characterize this collection. Simple lines, a well-thought-out arrangement of cabinets and solid fronts will certainly serve and delight with their charm for many years.



LILIANA FOLIA

- Foliowane fronty MDF 19 mm, dostępne w 10 wersjach kolorystycznych.
- Dekoracyjny ramiakowy front.
- Najmodniejszy wzór nadchodzącego sezonu.

dostępna kolorystyka frontów, korpusów, blatów s. **56, 52, 117**
wykaz dostępnych szafek s. **57-61**

- Lacquered MDF fronts 19 mm, available in 10 color versions.
- Decorative framed front.
- The most fashionable pattern of the coming season.

available colors of fronts, cabinets, worktops p. **56, 52, 117**
specification of available cabinets p. **57-61**



mat
mat



dostępne inne
wybarwienia
other colors available

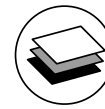

blat do wyboru
worktop to
choose from

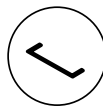

metalowy uchwyt
metal handle

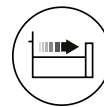

szuflada pełen wysuw
ciche domykanie
full extension drawer
soft closing



ciche domykanie frontów
softclose system

Doskonałe proporcje i elegancką formę z przyjemnością przygotowaliśmy najmodniejszą kolorystyką. Pudrowy róż, butelkowa zieleń, klasyczne beże i szarości, to wszystko znajdziesz w ofercie kuchni Liliana folia. W przypadku tej kuchni ograniczeniem będzie wyłącznie Twoja wyobraźnia.

We were happy to add the most fashionable colors to the perfect proportions and elegant form. Powder pink, bottle green, classic beiges and greys, you will find it all in the Liliana foil kitchen offer. In the case of this kitchen, the only limit will be your imagination.



MONIUSZKO

- Ponadczasowy design.
- Frezowane fronty.
- Szeroki wybór szafek.
- Bogata kolorystyka frontów lakierowanych.

dostępna kolorystyka frontów, korpusów, blatów s. **54, 52, 117**
wykaz dostępnych szafek s. **57-61**

- Timeless design.
- Milled fronts.
- Wide cupboard selection.
- The wide palette of lacquered fronts.

available colors of fronts, cabinets, worktops p. **54, 52, 117**
specification of available cabinets p. **57-61**



wysoki połysk & mat
high gloss & mat



dostępne inne
wybarwienia
other colors available

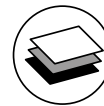

blat do wyboru
worktop to
choose from

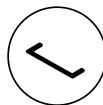

metalowy uchwyt
metal handle

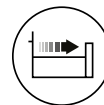

szuflada pełen wysuw
ciche domykanie
full extension drawer
soft closing



ciche domykanie frontów
softclose system

Meble kuchenne Moniuszko to połączenie nowoczesności z klasyką. Perfekcyjne wykończenie każdego detalu, modna kolorystyka i elegancka forma wpisuje się w gusta nawet najbardziej wymagających klientów. Bogaty wybór szafek daje ogromne możliwości indywidualnej zabudowy.

The Moniuszko kitchen design is a fusion of new and classic. Perfect finish of every detail, fashionable colours and elegant form will satisfy even the most demanding clients. Rich selection of cupboards gives great possibilities for individual arrangements.

JAKOŚĆ FUNKCJONALNOŚĆ DESIGN NIEZAWODNOŚĆ

Acrylux Mat Anti-fingerprint
hydrofobowa powierzchnia,
odporna na "ślady palców"

Ekologiczne płyty meblowe
100% drewna z recyklingu

Spectrum Metal
powierzchnie metaliczne
w najmodniejszych odcieniach



Prosty sposób
na personalizację mebli
A jaki jest Twój styl?

www.hettich.com

Technik für Möbel

Hettich

Korpusy / Bodies płyta laminowana 16mm / laminated board

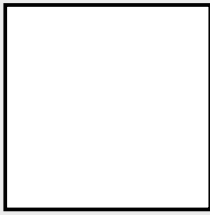

BIAŁY PCV
WHITE



SZARY GRAFIT PCV
GREY GRAPHITE



SZARA PLATYNA PCV
PLATINIUM GREY

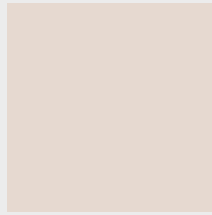

BEŻ PIASKOWY PCV
SAND BEIGE



DĄB BURLINGTON PCV
OAK BURLINGTON

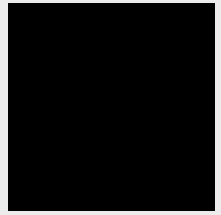

CZARNY GROSZEK PCV
BLACK SEMI MAT PCV

Alvico płyty 18mm Luxe i Synchron / Luxe & Synchron board

Unicolour



ALVICO



LUXE | BLANCO



LUXE | MAGNOLIA



LUXE | CASHMIRE



LUXE | GRIS03

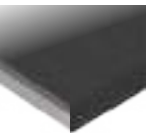

LUXE | ANTRACITA



LUXE | NEGRO

Design



LUXE | CUZCO ORO



LUXE | CUZCO SILVER



LUXE | CUZCO GRAFIT



SYNCRON | OXID 01
SILVER MAT



SYNCRON | OXID 04
GRAFIT MAT



LUXE | METALLO 01

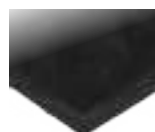

LUXE | METALLO 04



SYNCRON | ORIENTAL
BLACK MAT



SYNCRON | ORIENTAL
WHITE MAT



SYNCRON | OSIRIS
COBRE

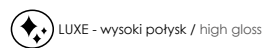

Oliwia płyta laminowana 18 mm krawędź PCV / laminated board PCV edge



OLIWIA

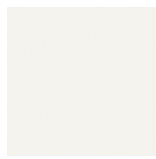

BIAŁA ALASKA
WHITE ALASKA



DĄB BISZKOPIOWY
BISCUIT OAK



DĄB WERSAL
VERSAL OAK



DĄB BURLINGTON
OAK BURLINGTON



SZARY KAMIENNY
GRAY STONE



SZARY GRAFIT
GRAPHITE GREY



BEŻ PIASKOWY
SAND BEIGE

Naomi płyta akrylowa 18,6 mm Velvet Ultra matt / acrylic board 18,6 mm Velvet ultra matt

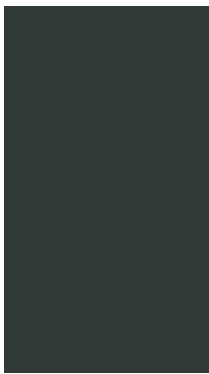

NAOMI

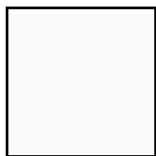

BIAŁY ALPEJSKI
ALPINE WHITE



SZARY
GREY



JASNY BEŻOWY
LIGHT BEIGE



CZARNY
BLACK



ANTRACYTOWY
ANTRACITE



CIEMNY NIEBIESKI
DARK BLUE



CEGLASTY
BRICK RED



BRAZOWY
BRONZE



CIEMNY ZIELONY
DARK GREEN

Ramki aluminiowe R1 Aluminum frames R1



Kolorystyka ramek Frame colors

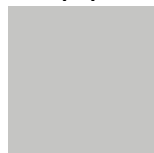

ALUMINIUM
ALUMINIUM



CZARNY
BLACK



ZŁOTY
GOLD

Kolorystyka szkła Glass colors

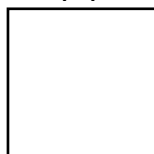

PRZEZROCZYSTE
TRANSPARENT



ANTISOL GRAFIT
ANTISOL GRAPHITE

Alicja, Grace, Liliana, Dafne Fronty lakierowane MDF 19 MM / MDF lacquered fronts

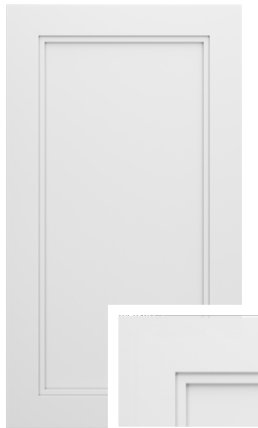

ALICJA



GRACE



LILIANA



DAFNE

Lakiery matowe / matte lacquers

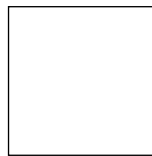

BIAŁY MAT
WHITE MATTE



PLATYNOWY MAT
PLATINUM MATTE



SREBRNY MAT
SILVER MATTE



SZARY MAT
SILVER MATTE



ANTRACYT MAT
ANTHRACITE MATTE



CZARNY MAT
BLACK MATTE



ZIELONY MAT
GREEN MATTE

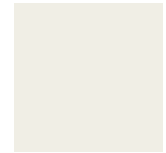

KREM MAT
CREAM MATTE



NUBE MAT
NUBE MATTE



GRANAT MAT
NAVY BLUE MATTE



SZAŁWIA MAT
SAGE MATTE

Moniuszko Fronty lakierowane MDF 19 MM / MDF lacquered fronts



MONIUSZKO

Lakiery matowe / matte lacquers

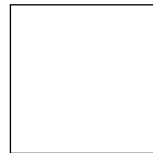

BIAŁY MAT
WHITE MATTE



PLATYNOWY MAT
PLATINUM MATTE



SREBRNY MAT
SILVER MATTE



SZARY MAT
SILVER MATTE



ANTRACYT MAT
ANTHRACITE MATTE



CZARNY MAT
BLACK MATTE



ZIELONY MAT
GREEN MATTE

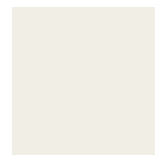

KREM MAT
CREAM MATTE



NUBE MAT
NUBE MATTE



GRANAT MAT
NAVY BLUE MATTE



SZAŁWIA MAT
SAGE MATTE

Lakiery połyskowe / gloss lacquers

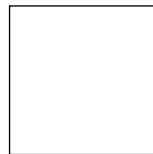

BIAŁY POŁYSK
WHITE GLOSS



PLATYNOWY POŁYSK
PLATINUM GLOSS



SREBRNY POŁYSK
SILVER GLOSS

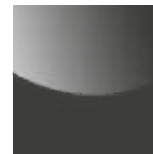

ANTRACYT POŁYSK
GLOSS ANTHRACITE



KREM POŁYSK
CREAM GLOSS



NUBE POŁYSK
NUBE GLOSS

Pola, Nina, Goya, Fronty lakierowane MDF 19 MM / MDF lacquered fronts



POLA



NINA

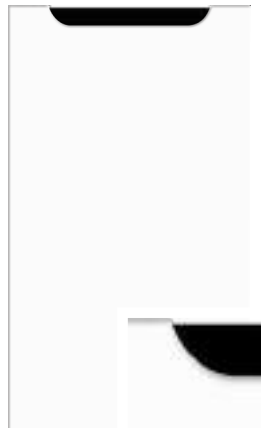

GOYA

Lakiery matowe / matte lacquers



BIAŁY MAT
WHITE MATTE

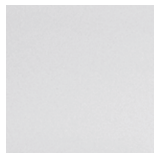

PLATYNOWY MAT
PLATINUM MATTE



SREBRNY MAT
SILVER MATTE



SZARY MAT
SILVER MATTE



ANTRACYT MAT
ANTHRACITE MATTE



CZARNY MAT
BLACK MATTE



ZIELONY MAT
GREEN MATTE

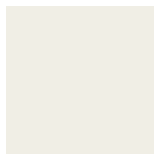

KREM MAT
CREAM MATTE



NUBE MAT
NUBE MATTE



GRANAT MAT
NAVY BLUE MATTE



SZALWIA MAT
SAGE MATTE

Lakiery połyskowe / gloss lacquers

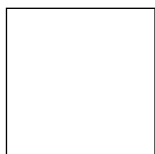

BIAŁY POŁYSK
WHITE GLOSS



PLATYNOWY POŁYSK
PLATINUM GLOSS



SREBRNY POŁYSK
SILVER GLOSS

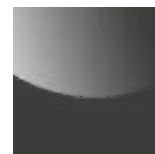

ANTRACYT POŁYSK
GLOSS ANTHRACITE



ZIELONY POŁYSK
GREEN GLOSS



KREM POŁYSK
CREAM GLOSS



NUBE POŁYSK
NUBE GLOSS

Alina, Anna Fronty lakierowane MDF 19 MM / MDF lacquered fronts



ALINA

ANNA

Lakiery matowe / matte lacquers

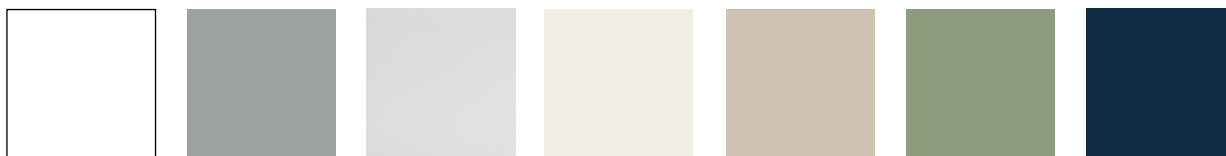

BIAŁY MAT
WHITE MATTE

SREBRNY MAT
SILVER MATTE

PLATYNOWY MAT
PLATINUM MATTE

KREM MAT
CREAM MATTE

NUBE MAT
NUBE MATTE

SZAŁWIA MAT
SAGE MATTE

GRANAT MAT*
NAVY BLUE MATTE*

Lakiery połyskowe / gloss lacquers



BIAŁY POŁYSK
WHITE GLOSS

PLATYNOWY POŁYSK
PLATINUM GLOSS

KREM POŁYSK
CREAM GLOSS

NUBE POŁYSK
NUBE GLOSS

*dostępne tylko w kuchni Alina

Anna, Dafne, Liliana, Alicja, Alina Fronty foliowane MDF 19 MM / MDF foiled fronts



ANNA

DAFNE

LILIANA

ALICJA

ALINA

folie mat / matt foil



BIAŁY GROSZEK MAT
WHITE SEMI MATTE

JASNY SZARY MAT
LIGHT GREY MATTE

SZARY MAT
SILVER MATTE

KREMOWY MAT
CREAM MATTE

COFFEE MAT
COFFEE MATTE

BEŻOWY SZARY MAT
BEIGE GRAY MATTE



PUDROWY RÓŻ
POWDER PINK



GRANAT MAT
NAVY BLUE MATTE



ZIELONY MAT
GREEN MATTE



CZARNY GROSZEK MAT
BLACK SEMI MATTE

Szafki górne na wysokość 1273mm, 1283mm / Top cabinets for a height of 1273mm, 1283mm

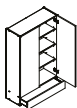

Szafka górna na wysokość 1273 mm
 Symbol Name **Wymiar [SxWxG] Dimension [WxHxD]**
 W 60 W S/1 600 x 1273 x 300
 W 80 W S/1 800 x 1273 x 300

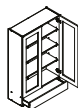

Szafka górna na wysokość 1273 mm
 Symbol Name **Wymiar [SxWxG] Dimension [WxHxD]**
 WS 60 W S/1 600 x 1273 x 300
 WS 80 W S/1 800 x 1273 x 300

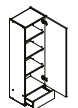

Szafka górna na wysokość 1273 mm
 Symbol Name **Wymiar [SxWxG] Dimension [WxHxD]**
 W 40 W S/1 P/L 400 x 1273 x 300

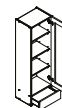

Szafka górna na wysokość 1273 mm
 Symbol Name **Wymiar [SxWxG] Dimension [WxHxD]**
 WS 40 W S/1 P/L 400 x 1273 x 300

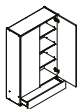

Szafka górna na wysokość 1283 mm
 Symbol Name **Wymiar [SxWxG] Dimension [WxHxD]**
 W 80 W S/1 800 x 1283 x 300
 W 60 W S/1 600 x 1283 x 300

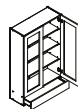

Szafka górna na wysokość 1283 mm
 Symbol Name **Wymiar [SxWxG] Dimension [WxHxD]**
 WS 80 W S/1 800 x 1283 x 300
 WS 60 W S/1 600 x 1283 x 300

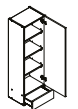

Szafka górna na wysokość 1283 mm
 Symbol Name **Wymiar [SxWxG] Dimension [WxHxD]**
 W 40 W S/1 P/L 400 x 1283 x 300

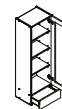

Szafka górna na wysokość 1283 mm
 Symbol Name **Wymiar [SxWxG] Dimension [WxHxD]**
 WS 40 W S/1 P/L 400 x 1283 x 300

...1273mm - blat 38mm
 ...1283mm - blat 28mm

Szafki górne na wysokość 920 / Top cabinets for a height of 920mm

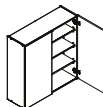

Szafka górna na wysokość 920 mm
 Symbol Name **Wymiar [SxWxG] Dimension [WxHxD]**
 W 90 / 92 900 x 920 x 300
 W 80 / 92 800 x 920 x 300
 W 60 / 92 600 x 920 x 300

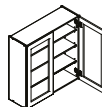

Szafka górna na wysokość 920 mm
 Symbol Name **Wymiar [SxWxG] Dimension [WxHxD]**
 WS 80 / 92 800 x 920 x 300
 WS 60 / 92 600 x 920 x 300



Szafka górna na wysokość 920 mm
 Symbol Name **Wymiar [SxWxG] Dimension [WxHxD]**
 W 80 SU / 92 800 x 920 x 300
 W 60 SU / 92 600 x 920 x 300

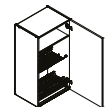

Szafka górna na wysokość 920 mm
 Symbol Name **Wymiar [SxWxG] Dimension [WxHxD]**
 W 60 SU / P/L / 92 600 x 920 x 300
 W 50 SU / P/L / 92 500 x 920 x 300

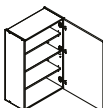

Szafka górna na wysokość 920 mm
 Symbol Name **Wymiar [SxWxG] Dimension [WxHxD]**
 W 60 P/L / 92 600 x 920 x 300
 W 50 P/L / 92 500 x 920 x 300
 W 45 P/L / 92 450 x 920 x 300
 W 40 P/L / 92 400 x 920 x 300
 W 30 P/L / 92 300 x 920 x 300

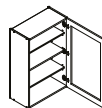

Szafka górna na wysokość 920 mm
 Symbol Name **Wymiar [SxWxG] Dimension [WxHxD]**
 WS 60 P/L / 92 600 x 920 x 300
 WS 40 P/L / 92 400 x 920 x 300
 WS 30 P/L / 92 300 x 920 x 300

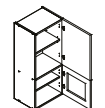

Szafka górna na wysokość 920 mm
 Symbol Name **Wymiar [SxWxG] Dimension [WxHxD]**
 W 40 P/L SD / 92 400 x 920 x 300

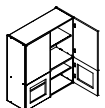

Szafka górna na wysokość 920 mm
 Symbol Name **Wymiar [SxWxG] Dimension [WxHxD]**
 W 80 SD / 92 800 x 920 x 300

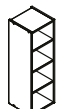

Szafka górna na wysokość 920 mm
 Symbol Name **Wymiar [SxWxG] Dimension [WxHxD]**
 WO 30 / 92 300 x 920 x 300
 WO 20 / 92 200 x 920 x 300
 WO 15 / 92 150 x 920 x 300

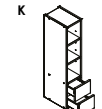

Szafka górna na wysokość 920 mm
 Symbol Name **Wymiar [SxWxG] Dimension [WxHxD]**
 WO 20 S/2 / 92 200 x 920 x 300

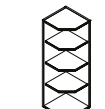

Szafka górna na wysokość 920 mm
 Symbol Name **Wymiar [SxWxG] Dimension [WxHxD]**
 WPO / 92 300 x 920 x 300

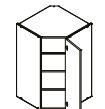

Szafka górna na wysokość 920 mm
 Symbol Name **Wymiar [SxWxG] Dimension [WxHxD]**
 WR P/L / 92 600 x 920 x 600

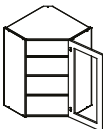

Szafka górna na wysokość 920 mm
 Symbol Name **Wymiar [SxWxG] Dimension [WxHxD]**
 WRS P/L / 92 600 x 920 x 600

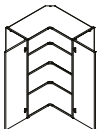

Szafka górna na wysokość 920 mm
 Symbol Name **Wymiar [SxWxG] Dimension [WxHxD]**
 WRN P/L / 92 600 x 920 x 600

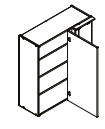

Szafka górna na wysokość 920 mm
 Symbol Name **Wymiar [SxWxG] Dimension [WxHxD]**
 WNP P/L / 92 800 x 920 x 350



Szafka górna na wysokość 920 mm
 Symbol Name **Wymiar [SxWxG] Dimension [WxHxD]**
 WS80 ALU / 92 800 x 920 x 300

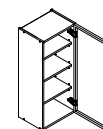

Szafka górna na wysokość 920 mm
 Symbol Name **Wymiar [SxWxG] Dimension [WxHxD]**
 WS60 P/L ALU / 92 600 x 920 x 300
 WS50 P/L ALU / 92 500 x 920 x 300
 WS45 P/L ALU / 92 450 x 920 x 300
 WS40 P/L ALU / 92 400 x 920 x 300

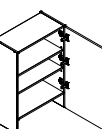

Szafka górna na wysokość 880 mm
 Symbol Name **Wymiar [SxWxG] Dimension [WxHxD]**
 W60 / 88 SLIM P/L 600 x 880 x 300
 W50 / 88 SLIM P/L 500 x 880 x 300

Szafki górne na wysokość 720 / Top cabinets for a height of 720mm

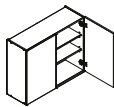

Szafka górna na wysokość 720 mm
 Symbol Name **Wymiar [SxWxG] Dimension [WxHxD]**
 W 90 / 72 900 x 720 x 300
 W 80 / 72 800 x 720 x 300
 W 60 / 72 600 x 720 x 300

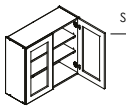

Szafka górna na wysokość 720 mm
 Symbol Name **Wymiar [SxWxG] Dimension [WxHxD]**
 WS 80 / 72 800 x 720 x 300
 WS 60 / 72 600 x 720 x 300

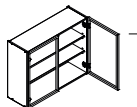

Szafka górna na wysokość 720 mm
 Symbol Name **Wymiar [SxWxG] Dimension [WxHxD]**
 WS80 ALU / 72 800 x 720 x 300

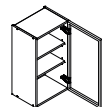

Szafka górna na wysokość 720 mm
 Symbol Name **Wymiar [SxWxG] Dimension [WxHxD]**
 WS60 P/L ALU / 72 600 x 720 x 300
 WS50 P/L ALU / 72 500 x 720 x 300
 WS45 P/L ALU / 72 450 x 720 x 300
 WS40 P/L ALU / 72 400 x 720 x 300

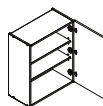

Szafka górna na wysokość 720 mm
 Symbol Name **Wymiar [SxWxG] Dimension [WxHxD]**
 W 60 P/L / 72 600 x 720 x 300
 W 50 P/L / 72 500 x 720 x 300
 W 45 P/L / 72 450 x 720 x 300
 W 40 P/L / 72 400 x 720 x 300
 W 30 P/L / 72 300 x 720 x 300

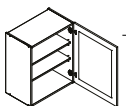

Szafka górna na wysokość 720 mm
 Symbol Name **Wymiar [SxWxG] Dimension [WxHxD]**
 WS 60 P/L / 72 600 x 720 x 300
 WS 40 P/L / 72 400 x 720 x 300
 WS 30 P/L / 72 300 x 720 x 300

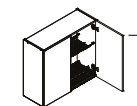

Szafka górna na wysokość 720 mm
 Symbol Name **Wymiar [SxWxG] Dimension [WxHxD]**
 W 80 SU / 72 800 x 720 x 300
 W 60 SU / 72 600 x 720 x 300

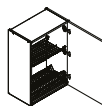

Szafka górna na wysokość 720 mm
 Symbol Name **Wymiar [SxWxG] Dimension [WxHxD]**
 W 60 SU P/L / 72 600 x 720 x 300
 W 50 SU P/L / 72 500 x 720 x 300

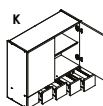

Szafka górna na wysokość 720 mm
 Symbol Name **Wymiar [SxWxG] Dimension [WxHxD]**
 W 80 S/5 / 72 800 x 720 x 300

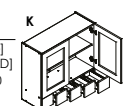

Szafka górna na wysokość 720 mm
 Symbol Name **Wymiar [SxWxG] Dimension [WxHxD]**
 WS 80 S/5 / 72 800 x 720 x 300

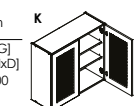

Szafka górna na wysokość 720 mm
 Symbol Name **Wymiar [SxWxG] Dimension [WxHxD]**
 W 80 KRATKA / 72 800 x 720 x 300

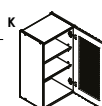



Szafka górna na wysokość 720 mm
 Symbol Name **Wymiar [SxWxG] Dimension [WxHxD]**
 W 60 KRATKA P/L / 72 600 x 720 x 300
 W 40 KRATKA P/L / 72 400 x 720 x 300

*N, K - szafki oznaczone literą „N” występują tylko w kuchniach nowoczesnych, „K” występują tylko w kuchniach klasycznych. Pozostałe szafki występują we wszystkich modelach kuchni.

*N, K - cabinets marked with “N” available for modern kitchens only. Cabinets marked with “K” available for classical kitchens only. Other cabinets available for all collections.

Szafki z frontami ramkami aluminiowymi otwierane są z pomocą TIP-ON w standardzie. Cabinets with fronts with aluminum frames are opened with TIP-ON as standard.

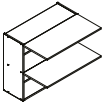
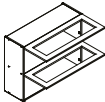
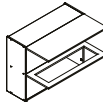
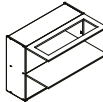
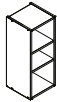
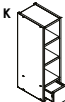
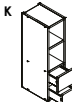

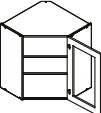
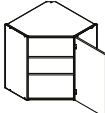
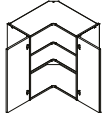
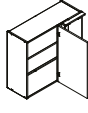
Szafka górna na wysokość 720 / Top cabinets for a height of 720mm

	Szafka górna na wysokość 720 mm Symbol Name W 90 GR F/2 / 72 W 80 GR F/2 / 72 W 60 GR F/2 / 72	Wymiar [SxWxG] Dimension [WxHxD] 900 x 720 x 300 800 x 720 x 300 600 x 720 x 300		Szafka górna na wysokość 720 mm Symbol Name WS 90 GR F/2 / 72 WS 80 GR F/2 / 72 WS 60 GR F/2 / 72	Wymiar [SxWxG] Dimension [WxHxD] 900 x 720 x 300 800 x 720 x 300 600 x 720 x 300		Szafka górna na wysokość 720 mm Symbol Name W 80 GR F/2 SD / 72 W 60 GR F/2 SD / 72	Wymiar [SxWxG] Dimension [WxHxD] 800 x 720 x 300 600 x 720 x 300		Szafka górna na wysokość 720 mm Symbol Name W 80 GR F/2 SG / 72 W 60 GR F/2 SG / 72	Wymiar [SxWxG] Dimension [WxHxD] 800 x 720 x 300 600 x 720 x 300
	Szafka górna na wysokość 720 mm Symbol Name WO 30 / 72 WO 20 / 72 WO 15 / 72	Wymiar [SxWxG] Dimension [WxHxD] 300 x 720 x 300 200 x 720 x 300 150 x 720 x 300		Szafka górna na wysokość 720 mm Symbol Name WO 20 S/1 / 72	Wymiar [SxWxG] Dimension [WxHxD] 200 x 720 x 300		Szafka górna na wysokość 720 mm Symbol Name WO 20 S/2 / 72	Wymiar [SxWxG] Dimension [WxHxD] 200 x 720 x 300		Szafka górna na wysokość 720 mm Symbol Name WPO / 72	Wymiar [SxWxG] Dimension [WxHxD] 300 x 720 x 300
	Szafka górna na wysokość 720 mm Symbol Name WRS P/L / 72	Wymiar [SxWxG] Dimension [WxHxD] 600 x 720 x 600		Szafka górna na wysokość 720 mm Symbol Name WR P/L / 72	Wymiar [SxWxG] Dimension [WxHxD] 600 x 720 x 600		Szafka górna na wysokość 720 mm Symbol Name WRN P/L / 72	Wymiar [SxWxG] Dimension [WxHxD] 600 x 720 x 600		Szafka górna na wysokość 720 mm Symbol Name WNP P/L / 72	Wymiar [SxWxG] Dimension [WxHxD] 800 x 720 x 350

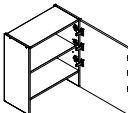
Szafka górna na wysokość 680 / Top cabinets for a height of 680mm

	Szafka górna na wysokość 680 mm Symbol Name W 60 / 68 SLIM P/L W 50 / 68 SLIM P/L	Wymiar [SxWxG] Dimension [WxHxD] 600 x 680 x 300 500 x 680 x 300
--	--	---

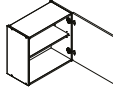

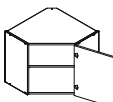
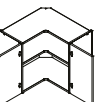
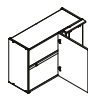
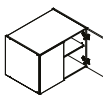
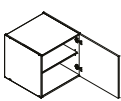
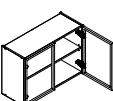
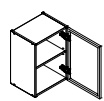
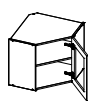
Szafka górna na wysokość 560 / Top cabinets for a height of 560mm

	Szafka górna na wysokość 560 mm Symbol Name W 90 / 56 W 80 / 56 W 60 / 56	Wymiar [SxWxG] Dimension [WxHxD] 900 x 560 x 300 800 x 560 x 300 600 x 560 x 300		Szafka górna na wysokość 560 mm Symbol Name W 60 P/L / 56 W 50 P/L / 56 W 45 P/L / 56 W 40 P/L / 56 W 30 P/L / 56	Wymiar [SxWxG] Dimension [WxHxD] 600 x 560 x 300 500 x 560 x 300 450 x 560 x 300 400 x 560 x 300 300 x 560 x 300		Szafka górna na wysokość 560 mm Symbol Name WO 30 / 56 WO 20 / 56 WO 15 / 56	Wymiar [SxWxG] Dimension [WxHxD] 300 x 560 x 300 200 x 560 x 300 150 x 560 x 300		Szafka górna na wysokość 560 mm Symbol Name WPO / 56	Wymiar [SxWxG] Dimension [WxHxD] 300 x 560 x 300
	Szafka górna na wysokość 560 mm Symbol Name WR P/L / 56	Wymiar [SxWxG] Dimension [WxHxD] 600 x 560 x 600		Szafka górna na wysokość 560 mm Symbol Name WRN P/L / 56	Wymiar [SxWxG] Dimension [WxHxD] 600 x 560 x 600		Szafka górna na wysokość 560 mm Symbol Name WNP P/L / 56	Wymiar [SxWxG] Dimension [WxHxD] 800 x 560 x 350		Szafka na wys. 560 mm gł. 560 mm Symbol Name W 80 / 56 / 56	Wymiar [SxWxG] Dimension [WxHxD] 800 x 560 x 560
	Szafka na wys. 560 mm gł. 560 mm Symbol Name W 60 P/L / 56 / 56 W 50 P/L / 56 / 56	Wymiar [SxWxG] Dimension [WxHxD] 600 x 560 x 560 500 x 560 x 560		Szafka górna na wysokość 560 mm Symbol Name WS80 ALU / 72	Wymiar [SxWxG] Dimension [WxHxD] 800 x 560 x 300		Szafka górna na wysokość 560 mm Symbol Name WS60 P/L ALU / 56 WS50 P/L ALU / 56 WS45 P/L ALU / 56 WS40 P/L ALU / 56	Wymiar [SxWxG] Dimension [WxHxD] 600 x 560 x 300 500 x 560 x 300 450 x 560 x 300 400 x 560 x 300		Szafka górna na wysokość 560 mm Symbol Name WRS P/L / 56	Wymiar [SxWxG] Dimension [WxHxD] 600 x 560 x 600

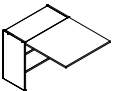
Szafka górna na wysokość 520 / Top cabinets for a height of 520mm

	Szafka górna na wysokość 520 mm Symbol Name W 60 OK GR SLIM / 52 W 50 OK GR SLIM / 52	Wymiar [SxWxG] Dimension [WxHxD] 600 x 520 x 300 500 x 520 x 300
--	--	---

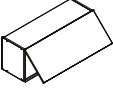
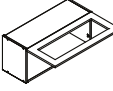
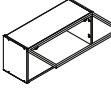
Szafka górna na wysokość 360 / Top cabinets for a height of 360mm

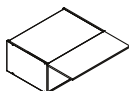
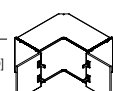
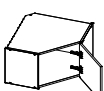
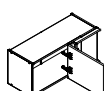
	Szafka górna na wysokość 360 mm Symbol Name W 90 OK GR W 80 OK GR W 60 OK GR W 50 OK GR W 40 OK GR	Wymiar [SxWxG] Dimension [WxHxD] 900 x 360 x 300 800 x 360 x 300 600 x 360 x 300 500 x 360 x 300 400 x 360 x 300		Szafka górna na wysokość 360 mm Symbol Name WS 80 OK GR WS 60 OK GR	Wymiar [SxWxG] Dimension [WxHxD] 800 x 360 x 300 600 x 360 x 300		Szafka górna na wysokość 360 mm Symbol Name WS 80 OK GR ALU WS 60 OK GR ALU WS 50 OK GR ALU WS 45 OK GR ALU WS 40 OK GR ALU	Wymiar [SxWxG] Dimension [WxHxD] 800 x 360 x 300 600 x 360 x 300 500 x 360 x 300 450 x 360 x 300 400 x 360 x 300		Szafka górna na wysokość 360 mm Symbol Name WO 60 MV	Wymiar [SxWxG] Dimension [WxHxD] 600 x 360 x 360
	Szafka na wys. 360 mm gł. 560 mm Symbol Name W 90 OK GR / Gt. 56 W 80 OK GR / Gt. 56 W 60 OK GR / Gt. 56 W 50 OK GR / Gt. 56	Wymiar [SxWxG] Dimension [WxHxD] 900 x 360 x 560 800 x 360 x 560 600 x 360 x 560 500 x 360 x 560		Szafka górna na wys. 360 mm Symbol Name WRN P/L 36	Wymiar [SxWxG] Dimension [WxHxD] 600 x 360 x 600		Szafka górna na wys. 360 mm Symbol Name WR P/L / 36	Wymiar [SxWxG] Dimension [WxHxD] 600 x 360 x 600		Szafka górna na wys. 360 mm Symbol Name WNP P/L/36	Wymiar [SxWxG] Dimension [WxHxD] 800 x 360 x 350

*N, K - szafki oznaczone literą „N” występują tylko w kuchniach nowoczesnych, „K” występują tylko w kuchniach klasycznych. Pozostałe szafki występują we wszystkich modelach kuchni.

*N, K - cabinets marked with “N” available for modern kitchens only. Cabinets marked with “K” available for classical kitchens only. Other cabinets available for all collections.

Szafki z frontami ramkami aluminiowymi otwierane są za pomocą TIP-ON w standardzie. Cabinets with fronts with aluminum frames are opened with TIP-ON as standard.

Szafki dolne / Bottom cabinets

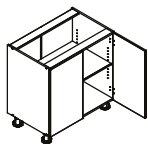

Szafka na wysokość 820 mm
(wys. szafki bez blatu)

Symbol Name	Wymiar [SxWxG] Dimension [WxHxD]
D 90	900 x 820 x 524
D 80	800 x 820 x 524
D 60	600 x 820 x 524

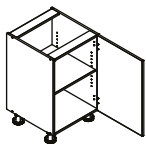

Szafka na wysokość 820 mm
(wys. szafki bez blatu)

Symbol Name	Wymiar [SxWxG] Dimension [WxHxD]
D 60 P/L	600 x 820 x 524
D 50 P/L	500 x 820 x 524
D 45 P/L	450 x 820 x 524
D 40 P/L	400 x 820 x 524
D 30 P/L	300 x 820 x 524

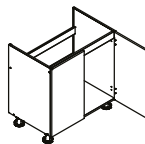

Szafka na wysokość 820 mm
(wys. szafki bez blatu)

Symbol Name	Wymiar [SxWxG] Dimension [WxHxD]
D 90 ZL	900 x 820 x 524
D 80 ZL	800 x 820 x 524
D 60 ZL	600 x 820 x 524

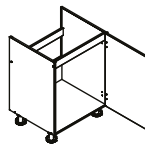

Szafka na wysokość 820 mm
(wys. szafki bez blatu)

Symbol Name	Wymiar [SxWxG] Dimension [WxHxD]
D 60 ZL P/L	600 x 820 x 524
D 50 ZL P/L	500 x 820 x 524



Szafka na wysokość 820 mm
(wys. szafki bez blatu)

Symbol Name	Wymiar [SxWxG] Dimension [WxHxD]
D 60 ZL S/1	600 x 820 x 524

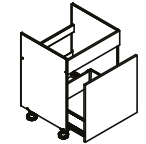

Szafka na wysokość 820 mm
(wys. szafki bez blatu)

Symbol Name	Wymiar [SxWxG] Dimension [WxHxD]
D 60 ZL ZAŚL. S/1	600 x 820 x 524
D 80 ZL ZAŚL. S/1	800 x 820 x 524

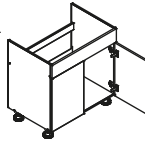

Szafka na wysokość 820 mm
(wys. szafki bez blatu)

Symbol Name	Wymiar [SxWxG] Dimension [WxHxD]
D 90 ZL ZAŚL.	900 x 820 x 524
D 80 ZL ZAŚL.	800 x 820 x 524
D 60 ZL ZAŚL.	600 x 820 x 524

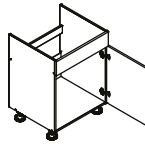

Szafka na wysokość 820 mm
(wys. szafki bez blatu)

Symbol Name	Wymiar [SxWxG] Dimension [WxHxD]
D 60 ZL ZAŚL. P/L	600 x 820 x 524
D 50 ZL ZAŚL. P/L	500 x 820 x 524

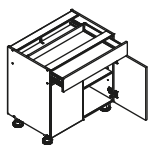

Szafka na wysokość 820 mm
(wys. szafki bez blatu)

Symbol Name	Wymiar [SxWxG] Dimension [WxHxD]
D 90 S/1	900 x 820 x 524
D 80 S/1	800 x 820 x 524
D 60 S/1	600 x 820 x 524

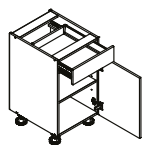

Szafka na wysokość 820 mm
(wys. szafki bez blatu)

Symbol Name	Wymiar [SxWxG] Dimension [WxHxD]
D 60 S/1 P/L	600 x 820 x 524
D 50 S/1 P/L	500 x 820 x 524
D 45 S/1 P/L	450 x 820 x 524
D 40 S/1 P/L	400 x 820 x 524
D 30 S/1 P/L	300 x 820 x 524

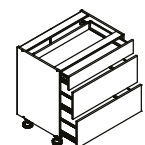

Szafka na wysokość 820 mm
(wys. szafki bez blatu)

Symbol Name	Wymiar [SxWxG] Dimension [WxHxD]
D 90 S/3	900 x 820 x 524
D 80 S/3	800 x 820 x 524
D 60 S/3	600 x 820 x 524
D 50 S/3	500 x 820 x 524
D 45 S/3	450 x 820 x 524
D 40 S/3	400 x 820 x 524
D 30 S/3	300 x 820 x 524

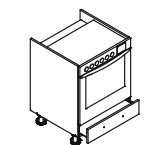

Szafka na wysokość 820 mm
(wys. szafki bez blatu)

Symbol Name	Wymiar [SxWxG] Dimension [WxHxD]
DK 60 S/1	600 x 820 x 524

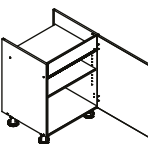

Szafka na wysokość 820 mm
(wys. szafki bez blatu)

Symbol Name	Wymiar [SxWxG] Dimension [WxHxD]
D 60 PC P/L	600 x 820 x 524

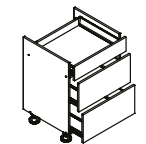

Szafka na wysokość 820 mm
(wys. szafki bez blatu)

Symbol Name	Wymiar [SxWxG] Dimension [WxHxD]
D 60 PC S/3	600 x 820 x 524
D 80 PC S/3	800 x 820 x 524

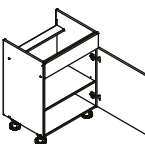

Szafka na wysokość 820 mm
(wys. szafki bez blatu)

Symbol Name	Wymiar [SxWxG] Dimension [WxHxD]
D 60 PC ZAŚL. P/L	600 x 820 x 524

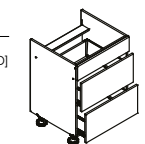

Szafka na wysokość 820 mm
(wys. szafki bez blatu)

Symbol Name	Wymiar [SxWxG] Dimension [WxHxD]
D 60 PC S/2 ZAŚL.	600 x 820 x 524
D 80 PC S/2 ZAŚL.	800 x 820 x 524

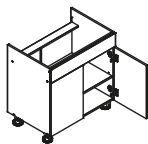

Szafka na wysokość 820 mm
(wys. szafki bez blatu)

Symbol Name	Wymiar [SxWxG] Dimension [WxHxD]
D 80 PC ZAŚL.	800 x 820 x 524

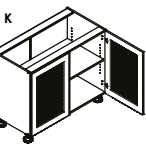

Szafka na wysokość 820 mm
(wys. szafki bez blatu)

Symbol Name	Wymiar [SxWxG] Dimension [WxHxD]
D 80 KRATKA	800 x 820 x 524

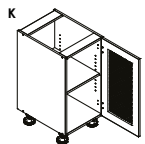

Szafka na wysokość 820 mm
(wys. szafki bez blatu)

Symbol Name	Wymiar [SxWxG] Dimension [WxHxD]
D 60 KRATKA P/L	600 x 820 x 524
D 40 KRATKA P/L	400 x 820 x 524

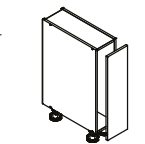

Szafka na wysokość 820 mm
(wys. szafki bez blatu)

Symbol Name	Wymiar [SxWxG] Dimension [WxHxD]
D 30 CARGO	300 x 820 x 524
D 20 CARGO	200 x 820 x 524
D 15 CARGO	150 x 820 x 524

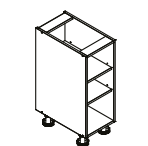

Szafka na wysokość 820 mm
(wys. szafki bez blatu)

Symbol Name	Wymiar [SxWxG] Dimension [WxHxD]
DO 30	300 x 820 x 524
DO 20	200 x 820 x 524

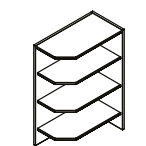

Szafka na wysokość 820 mm
(wys. szafki bez blatu)

Symbol Name	Wymiar [SxWxG] Dimension [WxHxD]
DPO	300 x 820 x 560

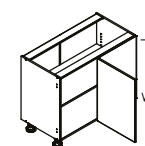

Szafka na wysokość 820 mm
(wys. szafki bez blatu)

Symbol Name	Wymiar [SxWxG] Dimension [WxHxD]
DNP P/L	900 x 820 x 524
WYMIAR PO BLACIE	1100 x 820 x 600

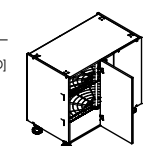

Szafka na wysokość 820 mm
(wys. szafki bez blatu)

Symbol Name	Wymiar [SxWxG] Dimension [WxHxD]
DNP P/L KOSZ	900 x 820 x 524
WYMIAR PO BLACIE	1100 x 820 x 600

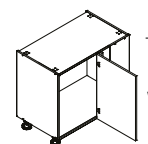

Szafka na wysokość 820 mm
(wys. szafki bez blatu)

Symbol Name	Wymiar [SxWxG] Dimension [WxHxD]
DNP P/L ZL	900 x 820 x 524
WYMIAR PO BLACIE	1100 x 820 x 600

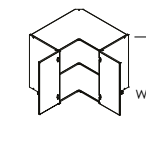

Szafka na wysokość 820 mm
(wys. szafki bez blatu)

Symbol Name	Wymiar [SxWxG] Dimension [WxHxD]
DRP P/L	864 x 820 x 864
WYMIAR PO BLACIE	900 x 820 x 900

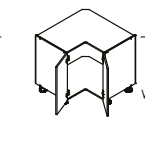

Szafka na wysokość 820 mm
(wys. szafki bez blatu)

Symbol Name	Wymiar [SxWxG] Dimension [WxHxD]
DRP P/L ZL	864 x 820 x 864
WYMIAR PO BLACIE	900 x 820 x 900

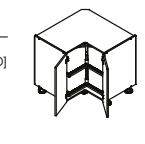

Szafka na wysokość 820 mm
(wys. szafki bez blatu)

Symbol Name	Wymiar [SxWxG] Dimension [WxHxD]
DRP P/L KOSZ	864 x 820 x 864
WYMIAR PO BLACIE	900 x 820 x 900

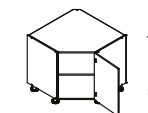

Szafka na wysokość 820 mm
(wys. szafki bez blatu)

Symbol Name	Wymiar [SxWxG] Dimension [WxHxD]
DRP P/L SKOS	864 x 820 x 864
WYMIAR PO BLACIE	900 x 820 x 900

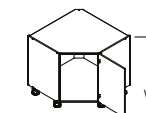

Szafka na wysokość 820 mm
(wys. szafki bez blatu)

Symbol Name	Wymiar [SxWxG] Dimension [WxHxD]
DRP P/L SKOS ZL	864 x 820 x 864
WYMIAR PO BLACIE	900 x 820 x 900

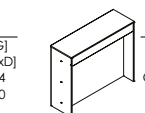

Szafka na wysokość 820 mm
(wys. szafki bez blatu)

Symbol Name	Wymiar [SxWxG] Dimension [WxHxD]
OBUDOWA WYSPY	1240 x 1016 x 410

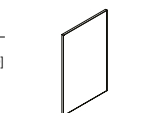

Front zmywarki

Symbol Name	Wymiar [SxWxG] Dimension [WxHxD]
FR ZM 60 PU	596 x 713
FR ZM 60 PO	596 x 570
FR ZM 45 PU	446 x 713
FR ZM 45 PO	446 x 570

* N, K - szafki oznaczone literą „N” występują tylko w kuchniach nowoczesnych, „K” występują tylko w kuchniach klasycznych. Pozostałe szafki występują we wszystkich modelach kuchni.
** Podane wymiary szafek dolnych uwzględniają wysokość nóżek 100 mm, nie uwzględniają wysokości blatu. W ofercie dostępne są również nóżki o wysokości 150 mm

* N, K - cabinets marked with “N” available for modern kitchens only. Cabinets marked with “K” available for classical kitchens only. Other cabinets available for all collections.
** Base cabinets dimensions are including feet height 100 mm. 150 mm legs are also available in the offer.

Śłupki / High cabinets / 1430, 1480mm

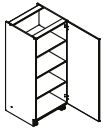

Szafka na wysokość 1430, 1480 mm

Symbol Name	Wymiar [SxWxG] Dimension [WxHxD]
D 60 SŁ P/L / 1430	600 x 1430 x 560
D 60 SŁ P/L / 1480	600 x 1480 x 560

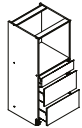

Szafka na wysokość 1430, 1480 mm

Symbol Name	Wymiar [SxWxG] Dimension [WxHxD]
D 60 PK S/3 / 1430	600 x 1430 x 560
D 60 PK S/3 / 1480	600 x 1480 x 560

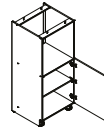

Szafka na wysokość 1430, 1480 mm

Symbol Name	Wymiar [SxWxG] Dimension [WxHxD]
D 60 PK / 1430	600 x 1430 x 560
D 60 PK P/L / 1480	600 x 1480 x 560

Śłupki / High cabinets / 2133, 2183mm

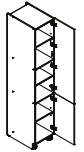

Szafka na wysokość 2133, 2183 mm

Symbol Name	Wymiar [SxWxG] Dimension [WxHxD]
D 60 SŁ P/L 2 FR / 2133	600 x 2133 x 560
D 40 SŁ P/L 2 FR / 2133	400 x 2133 x 560
D 60 SŁ P/L 2 FR / 2183	600 x 2183 x 560
D 40 SŁ P/L 2 FR / 2183	400 x 2183 x 560

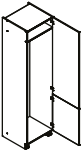

Szafka na wysokość 2133, 2183 mm

Symbol Name	Wymiar [SxWxG] Dimension [WxHxD]
D 60 LO P/L 2 FR / 2133	600 x 2133 x 560
D 60 LO P/L 2 FR / 2183	600 x 2183 x 560

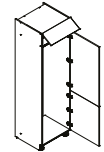

Szafka na wysokość 2133, 2183 mm

Symbol Name	Wymiar [SxWxG] Dimension [WxHxD]
D 60 LO P/L 3 FR / 2133	600 x 2133 x 560
D 60 LO P/L 3 FR / 2183	600 x 2183 x 560

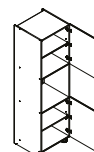

Szafka na wysokość 2133, 2183 mm

Symbol Name	Wymiar [SxWxG] Dimension [WxHxD]
D 60 PK P/L / 2133	600 x 2133 x 560
D 60 PK P/L / 2183	600 x 2183 x 560

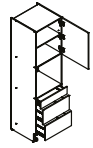

Szafka na wysokość 2133, 2183 mm

Symbol Name	Wymiar [SxWxG] Dimension [WxHxD]
D 60 PK S/3 P/L / 2133	600 x 2133 x 560
D 60 PK S/3 P/L / 2183	600 x 2183 x 560

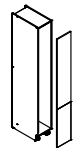

Szafka na wysokość 2133, 2183 mm

Symbol Name	Wymiar [SxWxG] Dimension [WxHxD]
D 30 CARGO MAXI 2133	300 x 2133 x 560
D 15 CARGO MAXI 2133	150 x 2133 x 560
D 30 CARGO MAXI 2183	300 x 2183 x 560
D 15 CARGO MAXI 2183	150 x 2183 x 560

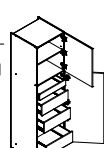

Szafka na wysokość 2133, 2183 mm

Symbol Name	Wymiar [SxWxG] Dimension [WxHxD]
D 60 SŁ ZP P/L 2133	600 x 2133 x 560
D 40 SŁ ZP P/L 2183	400 x 2183 x 560
D 40 SŁ ZP P/L 2133	400 x 2133 x 560
D 40 SŁ ZP P/L 2183	400 x 2183 x 560

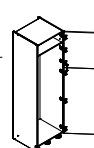

Szafka na wysokość 2133, 2183 mm

Symbol Name	Wymiar [SxWxG] Dimension [WxHxD]
D 60 SŁ TANDEM P/L 2133	600 x 2133 x 560
D 60 SŁ TANDEM P/L 2183	600 x 2183 x 560

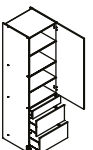

Szafka na wysokość 2133, 2183 mm

Symbol Name	Wymiar [SxWxG] Dimension [WxHxD]
D 60 SŁ S/3 P/L / 2133	600 x 2133 x 560
D 60 SŁ S/3 P/L / 2183	600 x 2183 x 560

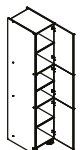

Szafka na wysokość 2133, 2183 mm

Symbol Name	Wymiar [SxWxG] Dimension [WxHxD]
D 60 SŁ P/L 3 FR / 2133	600 x 2133 x 560
D 60 SŁ P/L 3 FR / 2183	600 x 2183 x 560
D 40 SŁ P/L 3 FR / 2133	400 x 2133 x 560
D 40 SŁ P/L 3 FR / 2183	400 x 2183 x 560

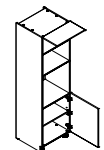

Szafka na wysokość 2133, 2183 mm

Symbol Name	Wymiar [SxWxG] Dimension [WxHxD]
D 60 PK MV P/L / 2133	600 x 2133 x 560
D 60 PK MV P/L / 2183	600 x 2183 x 560

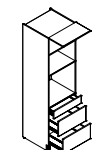

Szafka na wysokość 2133, 2183 mm

Symbol Name	Wymiar [SxWxG] Dimension [WxHxD]
D 60 PK MV S/3 / 2133	600 x 2133 x 560
D 60 PK MV S/3 / 2183	600 x 2183 x 560

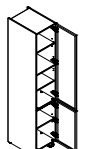

Szafka na wysokość 2133, 2183 mm

Symbol Name	Wymiar [SxWxG] Dimension [WxHxD]
D 40 SŁ ALU P/L 2133	400 x 2133 x 560
D 40 SŁ ALU P/L 2183	400 x 2183 x 560
D 60 SŁ ALU P/L 2133	600 x 2133 x 560
D 60 SŁ ALU P/L 2183	600 x 2183 x 560

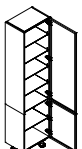

Szafka na wysokość 2133, 2183 mm

Symbol Name	Wymiar [SxWxG] Dimension [WxHxD]
D 40 SŁ FB ALU / 2133 P	400 x 2133 x 560
D 40 SŁ FB ALU / 2133 L	400 x 2133 x 560
D 40 SŁ FB ALU / 2183 P	400 x 2183 x 560
D 40 SŁ FB ALU / 2183 L	400 x 2183 x 560

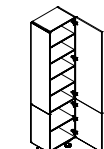

Szafka na wysokość 2133, 2183 mm

Symbol Name	Wymiar [SxWxG] Dimension [WxHxD]
D 40 SŁ FB / 2133 P	400 x 2133 x 560
D 40 SŁ FB / 2133 L	400 x 2133 x 560
D 40 SŁ FB / 2183 P	400 x 2183 x 560
D 40 SŁ FB / 2183 L	400 x 2183 x 560

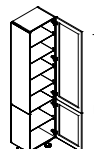

Szafka na wysokość 2133, 2183 mm

Symbol Name	Wymiar [SxWxG] Dimension [WxHxD]
D 40 SŁ FB SZKŁO / 2133 P	400 x 2133 x 560
D 40 SŁ FB SZKŁO / 2133 L	400 x 2133 x 560
D 40 SŁ FB SZKŁO / 2183 P	400 x 2183 x 560
D 40 SŁ FB SZKŁO / 2183 L	400 x 2183 x 560

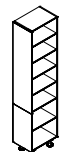

Szafka na wysokość 2133, 2183 mm

Symbol Name	Wymiar [SxWxG] Dimension [WxHxD]
D 40 SŁ FB PÓŁKA / 2133 P	400 x 2133 x 560
D 40 SŁ FB PÓŁKA / 2133 L	400 x 2133 x 560
D 40 SŁ FB PÓŁKA / 2183 P	400 x 2183 x 560
D 40 SŁ FB PÓŁKA / 2183 L	400 x 2183 x 560

Śłupki / High cabinets / 2333, 2383mm

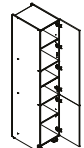

Szafka na wysokość 2333, 2383 mm

Symbol Name	Wymiar [SxWxG] Dimension [WxHxD]
D 60 SŁ P/L 2 FR / 2333	600 x 2333 x 560
D 40 SŁ P/L 2 FR / 2333	400 x 2333 x 560
D 60 SŁ P/L 2 FR / 2383	600 x 2383 x 560
D 40 SŁ P/L 2 FR / 2383	400 x 2383 x 560

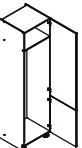

Szafka na wysokość 2333, 2383 mm

Symbol Name	Wymiar [SxWxG] Dimension [WxHxD]
D 60 LO P/L 2 FR / 2333	600 x 2333 x 560
D 60 LO P/L 2 FR / 2383	600 x 2383 x 560

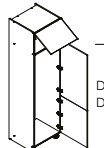

Szafka na wysokość 2333, 2383 mm

Symbol Name	Wymiar [SxWxG] Dimension [WxHxD]
D 60 LO P/L 3 FR / 2333	600 x 2333 x 560
D 60 LO P/L 3 FR / 2383	600 x 2383 x 560

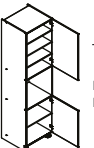

Szafka na wysokość 2333, 2383 mm

Symbol Name	Wymiar [SxWxG] Dimension [WxHxD]
D 60 PK P/L 2333	600 x 2333 x 560
D 60 PK P/L 2383	600 x 2383 x 560

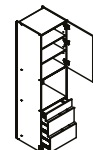

Szafka na wysokość 2333, 2383 mm

Symbol Name	Wymiar [SxWxG] Dimension [WxHxD]
D 60 PK S/3 P/L 2333	600 x 2333 x 560
D 60 PK S/3 P/L 2383	600 x 2383 x 560

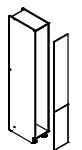

Szafka na wysokość 2333, 2383 mm

Symbol Name	Wymiar [SxWxG] Dimension [WxHxD]
D 30 CARGO MAXI / 2333	300 x 2333 x 560
D 15 CARGO MAXI / 2333	150 x 2333 x 560
D 30 CARGO MAXI / 2383	300 x 2383 x 560
D 15 CARGO MAXI / 2383	150 x 2383 x 560

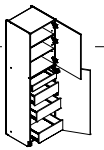

Szafka na wysokość 2333, 2383 mm

Symbol Name	Wymiar [SxWxG] Dimension [WxHxD]
D 60 SŁ ZP P/L 2333	600 x 2333 x 560
D 40 SŁ ZP P/L 2333	400 x 2333 x 560
D 60 SŁ ZP P/L 2383	600 x 2383 x 560
D 40 SŁ ZP P/L 2383	400 x 2383 x 560

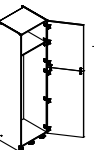

Szafka na wysokość 2333, 2383 mm

Symbol Name	Wymiar [SxWxG] Dimension [WxHxD]
D 60 SŁ TANDEM P/L 2333	600 x 2333 x 560
D 60 SŁ TANDEM P/L 2383	600 x 2383 x 560

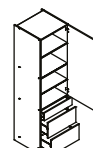

Szafka na wysokość 2333, 2383 mm

Symbol Name	Wymiar [SxWxG] Dimension [WxHxD]
D 60 SŁ S/3 P/L / 2333	600 x 2333 x 560
D 60 SŁ S/3 P/L / 2383	600 x 2383 x 560

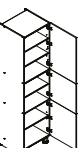

Szafka na wysokość 2333, 2383 mm

Symbol Name	Wymiar [SxWxG] Dimension [WxHxD]
D 60 SŁ P/L 3 FR 2333	600 x 2333 x 560
D 40 SŁ P/L 3 FR 2333	400 x 2333 x 560
D 60 SŁ P/L 3 FR 2383	600 x 2383 x 560
D 40 SŁ P/L 3 FR 2383	400 x 2383 x 560

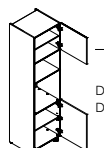

Szafka na wysokość 2333, 2383 mm

Symbol Name	Wymiar [SxWxG] Dimension [WxHxD]
D 60 PK MV P/L 2333	600 x 2333 x 560
D 60 PK MV P/L 2383	600 x 2383 x 560

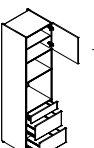

Szafka na wysokość 2333, 2383 mm

Symbol Name	Wymiar [SxWxG] Dimension [WxHxD]
D 60 PK MV S/3 P/L 2333	600 x 2333 x 560
D 60 PK MV S/3 P/L 2383	600 x 2383 x 560

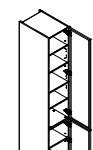

Szafka na wysokość 2333, 2383 mm

Symbol Name	Wymiar [SxWxG] Dimension [WxHxD]
D 40 SŁ ALU P/L 2333	400 x 2333 x 560
D 40 SŁ ALU P/L 2383	400 x 2383 x 560
D 60 SŁ ALU P/L 2333	600 x 2333 x 560
D 60 SŁ ALU P/L 2383	600 x 2383 x 560

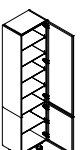

Szafka na wysokość 2333, 2383 mm

Symbol Name	Wymiar [SxWxG] Dimension [WxHxD]
D 40 SŁ FB ALU / 2333 P	400 x 2333 x 560
D 40 SŁ FB ALU / 2333 L	400 x 2333 x 560
D 40 SŁ FB ALU / 2383 P	400 x 2383 x 560
D 40 SŁ FB ALU / 2383 L	400 x 2383 x 560

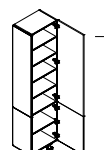

Szafka na wysokość 2333, 2383 mm

Symbol Name	Wymiar [SxWxG] Dimension [WxHxD]
D 40 SŁ FB / 2333 P	400 x 2333 x 560
D 40 SŁ FB / 2333 L	400 x 2333 x 560
D 40 SŁ FB / 2383 P	400 x 2383 x 560
D 40 SŁ FB / 2383 L	400 x 2383 x 560

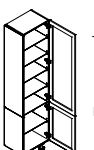

Szafka na wysokość 2333, 2383 mm

Symbol Name	Wymiar [SxWxG] Dimension [WxHxD]
D 40 SŁ FB SZKŁO / 2333 P	400 x 2333 x 560
D 40 SŁ FB SZKŁO / 2333 L	400 x 2333 x 560
D 40 SŁ FB SZKŁO / 2383 P	400 x 2383 x 560
D 40 SŁ FB SZKŁO / 2383 L	400 x 2383 x 560

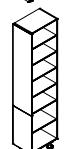

Szafka na wysokość 2333, 2383 mm

Symbol Name	Wymiar [SxWxG] Dimension [WxHxD]
D 40 SŁ FB PÓŁKA / 2333 P	400 x 2333 x 560
D 40 SŁ FB PÓŁKA / 2333 L	400 x 2333 x 560
D 40 SŁ FB PÓŁKA / 2383 P	400 x 2383 x 560
D 40 SŁ FB PÓŁKA / 2383 L	400 x 2383 x 560

Wymiary szafek dolnych podane są z uwzględnieniem nóżek o wysokości 100 mm. Istnieje możliwość zamówienia nóżki o wysokości 150 mm. Uwaga! w przypadku zmiany wysokości nóżek na 150 mm, szafka typu słupki należy zamawiać na wysokość wyższą o +50 mm. Wówczas zamiast szafek o wysokości 1430 mm należy zmienić wymiar na 1480 mm, analogicznie 2133 mm na 2183 mm oraz 2333 mm na 2383 mm. Zastosowanie się do powyższej zmiany ma istotny wpływ na zachowanie ciągłości linii wzoru frontu - szczególnie W PRZYPADKU FREZOWANYCH FRONTÓW.

Szafki dla osób z niepełnosprawnościami ruchowymi

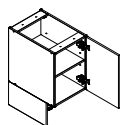

Szafka dolna na wysokość 820 mm

Symbol Name	Wymiar [SxWxG*] Dimension [WxHxD*]
N_D_40_PL	400 x 820 x 560
N_D_50_PL	500 x 820 x 560
N_D_60_PL	600 x 820 x 560

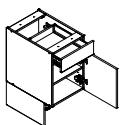

Szafka dolna na wysokość 820 mm

Symbol Name	Wymiar [SxWxG*] Dimension [WxHxD*]
N_D_40_S1	400 x 820 x 560
N_D_50_S1	500 x 820 x 560
N_D_60_S1	600 x 820 x 560

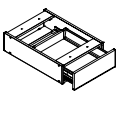

Szafka dolna na wysokość 148 mm

Symbol Name	Wymiar [SxWxG*] Dimension [WxHxD*]
N_D_40_S1_148	400 x 148 x 560
N_D_60_S1_148	600 x 148 x 560
N_D_80_S1_148	800 x 148 x 560

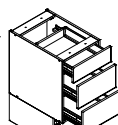

Szafka dolna na wysokość 820 mm

Symbol Name	Wymiar [SxWxG*] Dimension [WxHxD*]
N_D_40_S3	400 x 820 x 560
N_D_50_S3	500 x 820 x 560
N_D_60_S3	600 x 820 x 560

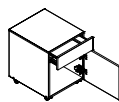

Szafka dolna na wysokość 646 mm

Symbol Name	Wymiar [SxWxG*] Dimension [WxHxD*]
N_kontenererek_S1_PL	450 x 646 x 500

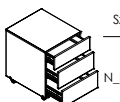

Szafka dolna na wysokość 646 mm

Symbol Name	Wymiar [SxWxG*] Dimension [WxHxD*]
N_kontenererek_S3	450 x 646 x 500

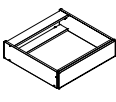

Szafka dolna na wysokość 148 mm

Symbol Name	Wymiar [SxWxG*] Dimension [WxHxD*]
N_D_60ZL_148	600 x 148 x 560
N_D_80ZL_148	800 x 148 x 560

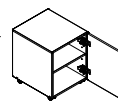

Szafka dolna na wysokość 646 mm

Symbol Name	Wymiar [SxWxG*] Dimension [WxHxD*]
N_kontenererek_PL	450 x 646 x 500

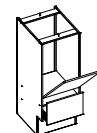

Szafka dolna na wysokość 1282 mm

Symbol Name	Wymiar [SxWxG*] Dimension [WxHxD*]
N_D_45_ZM_PU	482 x 1282x 560

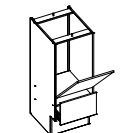

Szafka dolna na wysokość 1282 mm

Symbol Name	Wymiar [SxWxG*] Dimension [WxHxD*]
N_D_60_ZM_PU	632 x 1282 x 560

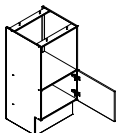

Szafka dolna na wysokość 1282 mm

Symbol Name	Wymiar [SxWxG*] Dimension [WxHxD*]
N_D_60_PK_PL	600 x 1282 x 560

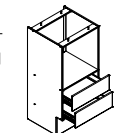

Szafka dolna na wysokość 1282 mm

Symbol Name	Wymiar [SxWxG*] Dimension [WxHxD*]
N_D_60_PK_S2	600 x 1282 x 560

*głębokość podana bez frontu.
*depth without front.

Szafki z okuciami marki BLUM®

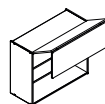

Szafka górna na wysokość 720 mm

Symbol Name	Wymiar [SxWxG] Dimension [WxHxD]
W 90 GR F/2 / 72 HF	900 x 720 x 300
W 80 GR F/2 / 72 HF	800 x 720 x 300
W 60 GR F/2 / 72 HF	600 x 720 x 300

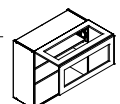

Szafka górna na wysokość 720 mm

Symbol Name	Wymiar [SxWxG] Dimension [WxHxD]
WS 90 GR F/2 / 72 HF	900 x 720 x 300
WS 80 GR F/2 / 72 HF	800 x 720 x 300
WS 60 GR F/2 / 72 HF	600 x 720 x 300

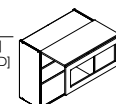

Szafka górna na wysokość 720 mm

Symbol Name	Wymiar [SxWxG] Dimension [WxHxD]
W 80 GR F/2 SD / 72 HF	800 x 720 x 300
W 60 GR F/2 SD / 72 HF	600 x 720 x 300

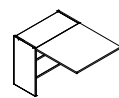

Szafka górna na wysokość 520 mm

Symbol Name	Wymiar [SxWxG] Dimension [WxHxD]
W 60 OK GR SLIM /52 HK	600 x 520 x 300
W 50 OK GR SLIM /52 HK	500 x 520 x 300

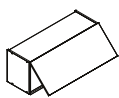

Szafka górna na wysokość 360 mm

Symbol Name	Wymiar [SxWxG] Dimension [WxHxD]
W 90 OK GR HK-S	900 x 360 x 300
W 80 OK GR HK-S	800 x 360 x 300
W 60 OK GR HK-S	600 x 360 x 300
W 50 OK GR HK-S	500 x 360 x 300
W 40 OK GR HK-S	400 x 360 x 300

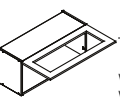

Szafka górna na wysokość 360 mm

Symbol Name	Wymiar [SxWxG] Dimension [WxHxD]
WS 80 OK GR HK-S	800 x 360 x 300
WS 60 OK GR HK-S	600 x 360 x 300

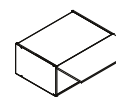

Szafka na wys. 360 mm gł. 560 mm

Symbol Name	Wymiar [SxWxG] Dimension [WxHxD]
W 90 OK GR / Gł. 56 HK-S	900 x 360 x 560
W 80 OK GR / Gł. 56 HK-S	800 x 360 x 560
W 60 OK GR / Gł. 56 HK-S	600 x 360 x 560
W 50 OK GR / Gł. 56 HK-S	500 x 360 x 560

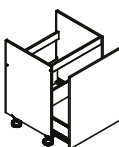

Szafka na wysokość 820 mm
(wys. szafki bez blatu)

Symbol Name	Wymiar [SxWxG] Dimension [WxHxD]
DB 60 ZL S/1	600 x 820 x 524

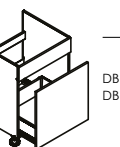

Szafka na wysokość 820 mm
(wys. szafki bez blatu)

Symbol Name	Wymiar [SxWxG] Dimension [WxHxD]
DB 60 ZL ZAŚL. S/1	600 x 820 x 524
DB 80 ZL ZAŚL. S/1	800 x 820 x 524

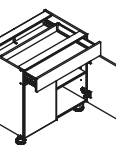

Szafka na wysokość 820 mm
(wys. szafki bez blatu)

Symbol Name	Wymiar [SxWxG] Dimension [WxHxD]
DB 90 S/1	900 x 820 x 524
DB 80 S/1	800 x 820 x 524
DB 60 S/1	600 x 820 x 524

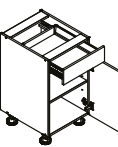

Szafka na wysokość 820 mm
(wys. szafki bez blatu)

Symbol Name	Wymiar [SxWxG] Dimension [WxHxD]
DB 60 S/1 P/L	600 x 820 x 524
DB 50 S/1 P/L	500 x 820 x 524
DB 45 S/1 P/L	450 x 820 x 524
DB 40 S/1 P/L	400 x 820 x 524
DB 30 S/1 P/L	300 x 820 x 524

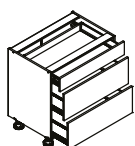

Szafka na wysokość 820 mm
(wys. szafki bez blatu)

Symbol Name	Wymiar [SxWxG] Dimension [WxHxD]
DB 90 S/3	900 x 820 x 524
DB 80 S/3	800 x 820 x 524
DB 60 S/3	600 x 820 x 524
DB 50 S/3	500 x 820 x 524
DB 45 S/3	450 x 820 x 524
DB 40 S/3	400 x 820 x 524
DB 30 S/3	300 x 820 x 524

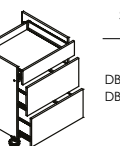

Szafka na wysokość 820 mm
(wys. szafki bez blatu)

Symbol Name	Wymiar [SxWxG] Dimension [WxHxD]
DB 60 PC S/3	600 x 820 x 524
DB 80 PC S/3	800 x 820 x 524

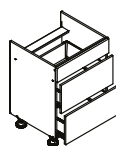

Szafka na wysokość 820 mm
(wys. szafki bez blatu)

Symbol Name	Wymiar [SxWxG] Dimension [WxHxD]
DB 60 PC S/2 ZAŚL.	600 x 820 x 524
DB 80 PC S/2 ZAŚL.	800 x 820 x 524

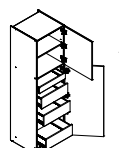

Szafka na wysokość 2133, 2183 mm

Symbol Name	Wymiar [SxWxG] Dimension [WxHxD]
DB 60 SL ZP P/L 2133	600 x 2133 x 560
DB 60 SL ZP P/L 2183	600 x 2183 x 560
DB 40 SL ZP P/L 2133	400 x 2133 x 560
DB 40 SL ZP P/L 2183	400 x 2183 x 560

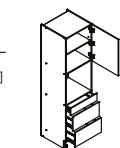

Szafka na wysokość 2133, 2183 mm

Symbol Name	Wymiar [SxWxG] Dimension [WxHxD]
DB 60 PK S/3 P/L / 2133	600 x 2133 x 560
DB 60 PK S/3 P/L / 2183	600 x 2183 x 560

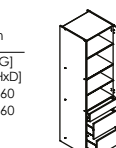

Szafka na wysokość 2133, 2183 mm

Symbol Name	Wymiar [SxWxG] Dimension [WxHxD]
DB 60 St.S/3 P/L / 2133	600 x 2133 x 560
DB 60 St.S/3 P/L / 2183	600 x 2183 x 560

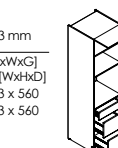

Szafka na wysokość 2133, 2183 mm

Symbol Name	Wymiar [SxWxG] Dimension [WxHxD]
DB 60 PK.MV S/3 / 2133	600 x 2133 x 560
DB 60 PK.MV S/3 / 2183	600 x 2183 x 560

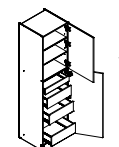

Szafka na wysokość 2333, 2383 mm

Symbol Name	Wymiar [SxWxG] Dimension [WxHxD]
DB 60 SL ZP P/L 2333	600 x 2333 x 560
DB 40 SL ZP P/L 2333	400 x 2333 x 560
DB 60 SL ZP P/L 2383	600 x 2383 x 560
DB 40 SL ZP P/L 2383	400 x 2383 x 560

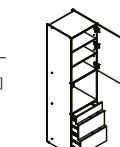

Szafka na wysokość 2333, 2383 mm

Symbol Name	Wymiar [SxWxG] Dimension [WxHxD]
DB 60 PK S/3 P/L 2333	600 x 2333 x 560
DB 60 PK S/3 P/L 2383	600 x 2383 x 560

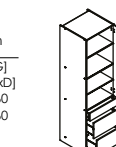

Szafka na wysokość 2333, 2383 mm

Symbol Name	Wymiar [SxWxG] Dimension [WxHxD]
DB 60 St.S/3 P/L / 2333	600 x 2333 x 560
DB 60 St.S/3 P/L / 2383	600 x 2383 x 560

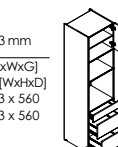

Szafka na wysokość 2333, 2383 mm

Symbol Name	Wymiar [SxWxG] Dimension [WxHxD]
DB 60 PK.MV S/3 P/L 2333	600 x 2333 x 560
DB 60 PK.MV S/3 P/L 2383	600 x 2383 x 560

Szafki dla osób z niepełnosprawnościami ruchowymi z okuciami marki BLUM®

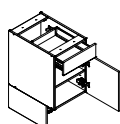

Szafka dolna na wysokość 820 mm

Symbol Name	Wymiar [SxWxG*] Dimension [WxHxD*]
N_DB_40_S1	400 x 820 x 560
N_DB_50_S1	500 x 820 x 560
N_DB_60_S1	600 x 820 x 560

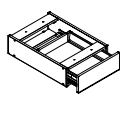

Szafka dolna na wysokość 148 mm

Symbol Name	Wymiar [SxWxG*] Dimension [WxHxD*]
N_DB_40_S1_148	400 x 148 x 560
N_DB_60_S1_148	600 x 148 x 560
N_DB_80_S1_148	800 x 148 x 560

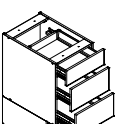

Szafka dolna na wysokość 820 mm

Symbol Name	Wymiar [SxWxG*] Dimension [WxHxD*]
N_DB_40_S3	400 x 820 x 560
N_DB_50_S3	500 x 820 x 560
N_DB_60_S3	600 x 820 x 560

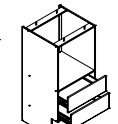

Szafka dolna na wysokość 1282 mm

Symbol Name	Wymiar [SxWxG*] Dimension [WxHxD*]
N_DB_60_PK_S2	600 x 1282 x 560

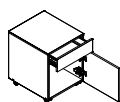

Szafka dolna na wysokość 646 mm

Symbol Name	Wymiar [SxWxG*] Dimension [WxHxD*]
NB_kontenererek_S1_PL	450 x 646 x 500

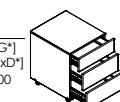

Szafka dolna na wysokość 646 mm

Symbol Name	Wymiar [SxWxG*] Dimension [WxHxD*]
NB_kontenererek_S3	450 x 646 x 500



TREND LINE

ADELE
BONO
DENIS
EMILY
IRMA
KATE
LIVIA
MAX
OSCAR
TRACY
ZOYA



TRENDline

TREND LINE to system mebli kuchennych, który oferuje najmodniejsze wzornictwo, ponadczasową kolorystykę i jakość na lata. Znajdziesz tu mnóstwo rozwiązań na stworzenie indywidualnej zabudowy Twojej wyjątkowej kuchni.

TREND LINE is a kitchen furniture system that offers the most fashionable design, timeless colors and quality for years. Here you will find plenty of solutions to create an individual layout for your unique kitchen.



IDEALNIE DOPASOWANA

W kuchni każdy centymetr jest na wagę złota. Oferujemy ponad 70 brył, dzięki którym stworzysz kuchnię idealnie dopasowaną do dostępnej przestrzeni. Dodatkowo, możliwość modyfikacji szafek, ułatwi zaprojektowanie nietypowego pomieszczenia.

AN IDEAL FIT

In the kitchen, every centimeter is very important. We offer over 70 cabinets, thanks to which you will create a kitchen ideally suited to the available space. In addition, the possibility of modifying the cabinets will facilitate work in an unusual room.



STAWIA NA FUNKCJONALNOŚĆ

W ofercie systemu Trend line znajdują Państwo również kosze typu cargo. Wąskie na butelki oraz kosze do szafek narożnych, dzięki czemu to czego potrzebujesz, będzie zawsze pod ręką.

FOCUSES ON FUNCTIONALITY

The Trend line system offer includes also cargo baskets. Narrow bottles and baskets for corner cabinets, so that what you need will always be close at hand.



WYGODA NA DZIŚ – JAKOŚĆ NA LATA

Wyjątkowa głębokość szafek dolnych [524 mm] oraz pojemne szuflady pomogą wygodnie zagospodarować każdą dostępną w kuchni przestrzeń.

CONVENIENCE FOR TODAY – QUALITY FOR YEARS.

The exceptional depth of the bottom cabinets [524 mm] and the spacious drawers will help you to functionally use every space available in the kitchen.



ZOBACZ WIĘCEJ

Oświetlenie to jeden z kluczowych elementów aranżacji w kuchni. Punktowe lampki, plafony LED, listwy LED w obudowie w kolorze korpusu – w naszej ofercie znajdziesz idealne oświetlenie meblowe do swojej kuchni.

SEE MORE

Lighting is one of the key elements of the arrangement in the kitchen. Spotlights, LED plafonds, LED strips in a housing in the color of the body - in our offer you will find the perfect furniture lighting for your kitchen.

CISZA W KUCHNI

Zawiasy oraz szuflady wyposażone w system cichego domykania gwarantują delikatne zamykanie i otwieranie frontów. W szafkach o szerokości powyżej 600 mm, 3 zawiasy w standardzie.

SILENCE IN THE KITCHEN

The hinges and drawers are equipped with the soft closing system to make the front open and shut in a delicate manner. In cabinets over 600 mm wide, 3 hinges as standard.

PIĘKNO TO SUMA DETALI

Kuchnia to nie tylko meble, ale również detale, dzięki którym nadajemy pomieszczeniu finalny charakter. Półki na metalowym stelażu z powrotem podkreślą loftowy styl twojego wnętrza.

BEAUTY IS THE SUM OF DETAILS

The kitchen is not only furniture, but also details, thanks to which we give the room its final character. Shelves on a metal frame will successfully emphasize the loft style of your interior.

SWOBODA WYBORU

Ponadczasowa czern, olśniewający chrom, a może najgorętsza propozycja tego sezonu - ognista miedź? W naszej ofercie znajdziesz uchwyt idealnie pasujący do Ciebie i twojego wnętrza.

FREEDOM OF CHOICE

Timeless black, shiny chrome, or maybe the hottest proposition of the season - fiery copper? In our offer you will find a handle perfectly matching you and your interior.

KOMPLETNA KUCHNIA W ZASIĘGU RĘKI

Oprócz bogatej oferty frontów i szafek, oferujemy również praktyczne akcesoria, dzięki którym przestrzeń w kuchni będzie nie tylko piękna, ale również funkcjonalna.

COMPLETE KITCHEN AT YOUR FINGERTIPS

In addition to the wide range of fronts and cabinets, we also offer practical accessories that will make the space in the kitchen not only beautiful, but also functional.

DLA MAŁYCH I DUŻYCH

Nóżki montażowe z możliwością regulacji pozwalają na stabilne ustawienie mebla nawet na nierównej powierzchni. Wysokość nóżek to 100 mm

FOR THE SHORT AND THE TALL

Adjusted legs make the furniture stand stable on uneven surfaces. The legs are available in size 100 mm.

ZAWSZE NA SWOIM MIEJSCU

Artystyczny nieład w szufladach – zapomnij o tym. Mamy dla ciebie wygodne wkłady, idealnie pasujące do naszych szuflad, w których każdy sztuciec znajdzie swoje miejsce.

ALWAYS IN PLACE

Artistic mess in the drawers - forget about it. We have comfortable inserts for you, perfectly matching our drawers, where each cutlery will find its place.

MAKSYMALNY MINIMALIZM

Nie możesz zdecydować się na konkretny model uchwytu, a może jesteś minimalistą? Postaw na rozwiązania bezuchwytowe i zastosuj w swojej kuchni odbojniki PUSH OPEN.*

MAXIMUM MINIMALISM

You can't decide on a specific handle model, or maybe you are a minimalist? Choose handle-free solutions and use PUSH OPEN bumpers in your kitchen.



*Rozwiązanie dedykowane wyłącznie do szafek z frontami uchylnymi. A solution dedicated only to cabinets with hinged fronts.

NOWOŚĆ

Rozwiązania dla osób z niepełnosprawnościami ruchowymi.

- Najważniejsze sprzęty i akcesoria kuchenne w zasięgu ręki.
- Dostępna pełna kolorystyka kolekcji Premium line oraz Trend line.
- Zastosowano okucia z systemu Premium line w standardzie.

dostępna kolorystyka frontów, korpusów, blatów s. **90-91, 117**
wykaz dostępnych szafek s. **92-93**

Solutions for people with mobility disabilities.

- The most important kitchen appliances and accessories at your fingertips.
- Full colors of the Premium line and Trend line collections available.
- Fittings from the Premium line system were used as standard.

available colors of fronts, cabinets, worktops p. **90-91, 117**
specification of available cabinets p. **92-93**



wysoki połysk & mat
high gloss & mat



dostępne inne
wybarwienia
other colors available

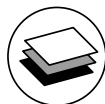

blat do wyboru
worktop to
choose from



metalowy uchwyt
metal handle



szuflada pełen wysuw
ciche domykanie
full extension drawer
soft closing



ciche domykanie frontów
softclose system

Kolekcja Premium line została rozbudowana o szafki zaprojektowane z myślą o potrzebach osób z niepełnosprawnościami ruchowymi. Piekarnik, zmywarka dostępne na wyciągnięcie dłoni, mobilne szafki na kółkach oraz podwieszane szafki dolne to tylko niektóre z przygotowanych udogodnień.

The Premium line collection has been expanded with cabinets designed to meet the needs of people with physical disabilities. An oven, dishwasher available at your fingertips, mobile cabinets on wheels and suspended lower cabinets are just some of the prepared amenities.





ADELE

- Perfekcyjne wykończenie detali.
- Wyraz aktualnych trendów wnętrzarskich.
- Elegancka forma.

dostępna kolorystyka frontów, korpusów, blatów s. **90, 117**
wykaz dostępnych szafek s. **92-93**

- The perfect finish of details.
- Expression of current interior trends.
- An elegant form.

available colors of fronts, cabinets, worktops p. **90, 117**
specification of available cabinets p. **92-93**

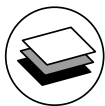

blat do wyboru
worktop to
choose from

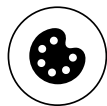

dostępne inne
wybarwienia
other colors available

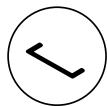

metalowy uchwyt
metal handle



ciche domykanie frontów
softclose system

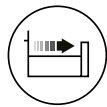

szuflada wysuw 3/4
ciche domykanie
3/4 extension drawer
soft closing



mat
mat

Adele to zdecydowanie propozycja dla osób poszukujących połączenia klasyki z nowoczesnością. W zależności od zastosowanego uchwytu Adele zyska klasyczny lub nowoczesny charakter. Fronty wykonano z 19 mm płyty MDF, pokryte folią PVC o matowym wykończeniu.

Adele is definitely an offer for those seeking a combination of classic and modern. Depending on the handle used, Adele will gain a classic or modern character. The fronts are made of 19 mm MDF, covered with a PVC foil with a matte finish.







BONO

- Możliwość łączenia z frontami OSCAR.
- Struktury imitujące naturalne drewno.
- Fronty z płyty laminowanej z obrzeżem ABS.

dostępna kolorystyka frontów, korpusów, blatów s. **90, 117**
wykaz dostępnych szafek s. **92-93**

- The possibility to create compositions with OSCAR fronts.
- Structures imitating natural wood.
- Laminated board fronts with ABS edge.

available colors of fronts, cabinets, worktops p. **90, 117**
specification of available cabinets p. **92-93**

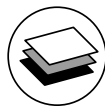

blat do wyboru
worktop to
choose from

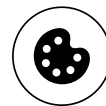

dostępne inne
wybarwienia
other colors available

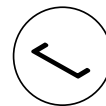

metalowy uchwyt
metal handle



ciche domykanie frontów
softclose system

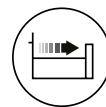

szuflada wysuw 3/4
ciche domykanie
3/4 extension drawer
soft closing



mat
mat

Bono to fronty niezwykle uniwersalne, doskonale wpiszą się w styl każdego wnętrza, a w połączeniu z frontami Oscar stworzą wyjątkowe kompozycje. Możliwość zamówienia paneli dekoracyjnych oraz cokołów w kolorze frontu, idealnie dopełnią każdą aranżację.

Bono are extremely versatile fronts, perfectly matching the style of any interior, and combined with Oscar fronts will create unique compositions. The possibility of ordering decorative panels and plinths in the color of the front will perfectly complement any arrangement.

DENIS

- Perfekcyjne wykończenie detali.
- Wyraz aktualnych trendów wnętrzarskich.
- Elegancka forma.

dostępna kolorystyka frontów, korpusów, blatów **s. 90, 117**
wykaz dostępnych szafek **s. 92-93**

- The perfect finish of details.
- Expression of current interior trends.
- An elegant form.

available colors of fronts, cabinets, worktops **p. 90, 117**
specification of available cabinets **p. 92-93**

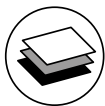

blat do wyboru
worktop to
choose from

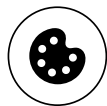

dostępne inne
wybarwienia
other colors available

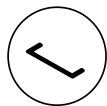

metalowy uchwyt
metal handle



ciche domykanie frontów
softclose system

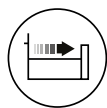

szuflada wysuw 3/4
ciche domykanie
3/4 extension drawer
soft closing



mat
mat

Denis to propozycja dla tych, którzy cenią sobie estetyczny minimalizm połączony z codzienną wygodą. Fronty wykonano z foliowanej płyty MDF o grubości 19mm, dostępne są w pięciu wersjach kolorystycznych: apetycznej caffè latte, matowej bieli oraz czarnego matu ze strukturą drobnego groszku, beżowym dębowym drewnie oraz granatowym macie.

Denis is an offer for those who appreciate aesthetic minimalism combined with everyday comfort. Fronts are made of foiled MDF board, 19 mm thick, available in five color versions: appetizing caffè latte, mat white and black mat with a structure of fine peas, beige oak wood and navy blue mat.





EMILY

- Proste bryły.
- Gładkie, niezakłócone uchwytami powierzchnie.
- Uniwersalny design.

dostępna kolorystyka frontów, korpusów, blatów s. **90, 52, 117**
wykaz dostępnych szafek s. **92-93**

- Simple shapes.
- Smooth undisturbed surfaces.
- Universal design.

available colors of fronts, cabinets, worktops p. **90, 52, 117**
specification of available cabinets p. **92-93**

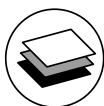

blat do wyboru
worktop to
choose from



dostępne inne
wybarwienia
other colors available



metalowy uchwyt
metal handle



ciche domykanie frontów
softclose system

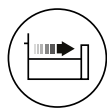

szuflada wysuw 3/4
ciche domykanie
3/4 extension drawer
soft closing



mat
mat

Prosta, geometryczna forma z odrobiną klasycznego sznytu – to idealna interpretacja kuchni Emily. Uroku nadaje jej frezowanie, tworzące wzór delikatnej ramki wokół krawędzi frontu. Na pozór klasyczna, bez problemu sprawdzi się w nowoczesnym wnętrzu.

A simple, geometric form with a touch of classic elegance - this is the perfect interpretation of Emily's kitchen. Its milling creates a delicate frame pattern around the edge of the front. Seemingly classic, it will work well in a modern interior.







IRMA

- Perfekcyjne wykończenie detali.
- Wyraz aktualnych trendów wnętrzarskich.
- Elegancka forma.

dostępna kolorystyka frontów, korpusów, blatów s. **90, 52, 117**
wykaz dostępnych szafek s. **92-93**

- The perfect finish of details.
- Expression of current interior trends.
- An elegant form.

available colors of fronts, cabinets, worktops p. **90, 52, 117**
specification of available cabinets p. **92-93**

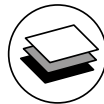

blat do wyboru
worktop to
choose from

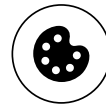

dostępne inne
wybarwienia
other colors available

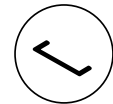

metalowy uchwyt
metal handle



ciche domykanie frontów
softclose system

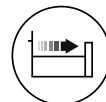

szuflada wysuw 3/4
ciche domykanie
3/4 extension drawer
soft closing



mat
mat



Irma to propozycja dla osób stawiających na klasykę w nowoczesnym wydaniu. Frezowane fronty łączą tradycyjne wzornictwo z eleganckim minimalizmem. Fronty wykonano z 19 mm płyty MDF pokrytej folią PCV o matowym wykończeniu. Na szczególną uwagę zasługuje kolor coffee, który jest kolorem przytulnym i stonowanym. Dzięki niemu uzyskamy kuchnię zachęcającą do relaksu, odprężenia i budowania domowej atmosfery.

Irma is an offer for people who prefer classics in a modern edition. Milled fronts combine traditional design with elegant minimalism. Fronts are made of 19 mm MDF board covered with PVC foil with a matte finish. Especially noteworthy is the color of coffee, which is a very cozy color. Thanks to it, we will get a kitchen that encourages relaxation, relaxation and building a home atmosphere.



KATE

- Ponadczasowy design.
- Duże gładkie powierzchnie frontów.
- Frezowane fronty.

dostępna kolorystyka frontów, korpusów, blatów s. **91, 52, 117**
wykaz dostępnych szafek s. **92-93**

- Timeless design.
- Large and smooth surfaces of the fronts.
- Milled fronts.

available colors of fronts, cabinets, worktops p. **91, 52, 117**
specification of available cabinets p. **92-93**

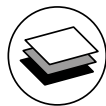

blat do wyboru
worktop to
choose from

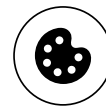

dostępne inne
wybarwienia
other colors available

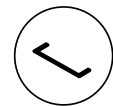

metalowy uchwyt
metal handle



ciche domykanie frontów
softclose system

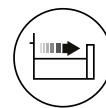

szuflada wysuw 3/4
ciche domykanie
3/4 extension drawer
soft closing



mat
mat

Kate to inspirowana stylistyką retro kuchnia o matowych, subtelnie ryflowanych frontach, wykonanych z foliowanej płyty MDF o grubości 16mm. Delikatne frezy interesująco urozmaicają jednobarwne powierzchnie. Znakomicie łączy się z innymi modelami z kolekcji Trend line, tworząc nietuzinkowe aranżacje.

Kate is a retro-inspired kitchen with matte, subtly grooved fronts made of 16mm foiled MDF board. Delicate milling cutters interestingly diversify single-colored surfaces. It is perfectly combined with other models from the Trend line collection, creating unusual arrangements.



LIVIA

- Ponadczasowy design.
- Duże gładkie powierzchnie frontów.
- Frezowane fronty.

dostępna kolorystyka frontów, korpusów, blatów s. **91, 52, 117**
wykaz dostępnych szafek s. **92-93**

- Timeless design.
- Large and smooth surfaces of the fronts.
- Milled fronts.

available colors of fronts, cabinets, worktops p. **91, 52, 117**
specification of available cabinets p. **92-93**



blat do wyboru
worktop to
choose from



dostępne inne
wybarwienia
other colors available



ciche domykanie frontów
softclose system



szuflada wysuw 3/4
ciche domykanie
3/4 extension drawer
soft closing



mat
mat

Livia to jeden z topowych wzorów frontów ostatnich sezonów. Delikatnie frezowane krawędzie umożliwiają otwieranie szafek, bez konieczności montowania uchwytów. Wzór wykonany z foliowanej płyty MDF o grubości 19mm, dostępny w kilku wersjach kolorystycznych.

Livia is one of the top front designs of recent seasons. Gently milled edges allow you to open cabinets without installing handles. The pattern is made of 19mm foil MDF, available in several colors.

MAX

- Aksamitnie matowa powierzchnia frontów.
- Idealna głębia kolorów.
- Kolorystyka nawiązująca do aktualnych trendów.

dostępna kolorystyka frontów, korpusów, blatów s. **91, 52, 117**
wykaz dostępnych szafek s. **92-93**

- Velvety matte surface of the fronts.
- Perfect color depth.
- Colors refer to current trends.

available colors of fronts, cabinets, worktops p. **91, 52, 117**
specification of available cabinets p. **92-93**



mat
mat



dostępne inne
wybarwienia
other colors available

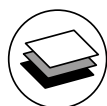

blat do wyboru
worktop to
choose from



metalowy uchwyt
metal handle

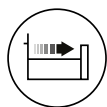

szuflada wysuw 3/4
ciche domykanie
3/4 extension drawer
soft closing



ciche domykanie frontów
softclose system

Max to kuchnia o kusząco matowych, aksamitnych w dotyku frontach, dostępnych w najmodniejszej kolorystyce. Idealnie gładkie powierzchnie doskonale wpiszą się w każde nowoczesne wnętrze. Ponadto, stanowią idealną bazę do wielu aranżacji.

Max is a kitchen with seductively matte, velvety to the touch fronts, available in the most fashionable colors. Perfectly smooth surfaces will fit perfectly into any modern interior. In addition, they are an ideal base for many arrangements.







OSCAR

- Akrylowe fronty w wysokim połysku.
- Gładka powierzchnia o prostych krawędziach.
- Dostępne dodatkowe panele boczne.

dostępna kolorystyka frontów, korpusów, blatów s. **91, 52, 117**
wykaz dostępnych szafek s. **92-93**

- High gloss acrylic fronts.
- Smooth surface with straight edges.
- Available additional decorative panels.

available colors of fronts, cabinets, worktops p. **91, 52, 117**
specification of available cabinets p. **92-93**



blat do wyboru
worktop to
choose from



dostępne inne
wybarwienia
other colors available



metalowy uchwyt
metal handle



ciche domykanie frontów
softclose system

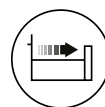

szuflada wysuw 3/4
ciche domykanie
3/4 extension drawer
soft closing



wysoki połysk
high gloss

Oscar to kuchnia, która dzięki swojej uniwersalności daje ogromne możliwości aranżacyjne, harmonijnie łącząc się z innymi frontami z systemu Trend line. Ponadczasowa biel oraz szlachetny antracyt doskonale będą wyglądać zarówno solo, jak i połączone z innymi dekorami w twoim wnętrzu.

Oscar is a kitchen that thanks to its universality, gives great arrangement possibilities, harmoniously connecting with other fronts from the Trend line system. Timeless white and noble anthracite will look great both solo and combined with other decors in your interior.

TRACY

- Ponadczasowy design.
- Trójwymiarowe frezowane fronty.
- Modna kolorystyka.

dostępna kolorystyka frontów, korpusów, blatów s. **91, 52, 117**
wykaz dostępnych szafek s. **92-93**

- Timeless design.
- Three-dimensional milled fronts.
- Fashionable colors.

available colors of fronts, cabinets, worktops p. **91, 52, 117**
specification of available cabinets p. **92-93**

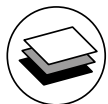

blat do wyboru
worktop to
choose from



dostępne inne
wybarwienia
other colors available

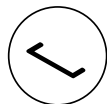

metalowy uchwyt
metal handle



ciche domykanie frontów
softclose system

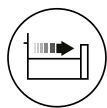

szuflada wysuw 3/4
ciche domykanie
3/4 extension drawer
soft closing



mat
mat

Tracy to wyraz inspiracji stylem retro. Kuchnia o matowych, szeroko ryflowanych frontach, wykonanych z foliowanej płyty MDF o grubości 16mm. Wyraźne frezy interesująco urozmaicają jednobarwne powierzchnie. Znakomicie łączy się z innymi modelami z kolekcji Trend line, tworząc nietuzinkowe aranżacje.

Tracy is an expression of retro inspiration. matt kitchen, wide grooved fronts, made of foil 16mm thick MDF boards. Clear cutters interestingly they diversify monochromatic surfaces. excellent it combines with other models from the Trend line collection, creating unusual arrangements.





ZOYA

- Proste bryły.
- Gładkie, niezakłócone uchwyty powierzchni.
- Uniwersalny design.

dostępna kolorystyka frontów, korpusów, blatów s. **91, 52, 117**
wykaz dostępnych szafek s. **92-93**

- Simple shapes.
- Smooth undisturbed surfaces.
- Universal design.

available colors of fronts, cabinets, worktops p. **91, 52, 117**
specification of available cabinets p. **92-93**

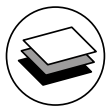

blat do wyboru
worktop to
choose from

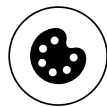

dostępne inne
wybarwienia
other colors available



ciche domykanie frontów
softclose system

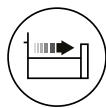

szuflada wysuw 3/4
ciche domykanie
3/4 extension drawer
soft closing



mat
mat

Zoya to nowoczesny wzór frontu wykonany z 19 mm płyty MDF, pokryty folią PVC dostępną w matowym wykończeniu. Matowa biel o strukturze bardzo drobnego groszku, szlachetna szarość o wyjątkowo gładkiej powierzchni oraz imitacja naturalnego drewna ze strukturą naśladowującą jego delikatne pory.

Zoya is a modern front design made of 19 mm MDF, covered with PVC foil available in a matte finish. Matte white with a very fine pea structure, noble gray with an extremely smooth surface and imitation of natural wood with a structure imitating its delicate pores.





Kolorystyka frontów / Colours of the fronts

ADELE

MDF FOLIA 19 MM
MDF FOIL 19 MM



BIAŁY GROSZEK MAT
WHITE SEMI MATTE

COFFE MAT
COFFEE MATTE

GRANAT MAT
NAVY BLUE MATTE

SZARY MAT
GRAY MATTE

BONO

PŁYTA LAMINOWANA 16 MM
LAMINATED BOARD 16 MM

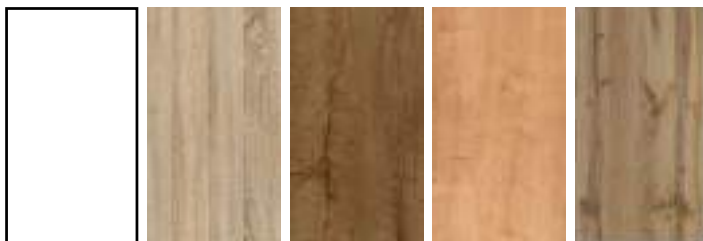

BIAŁA ALASKA
WHITE ALASKA

DĄB SONOMA
SONOMA OAK

DĄB LEFKAS
LEFKAS OAK

DĄB BURLINGTON
BURLINGTON OAK

DĄB WOTAN
WOTAN OAK

DENIS

MDF FOLIA 19 MM
MDF FOIL 19 MM

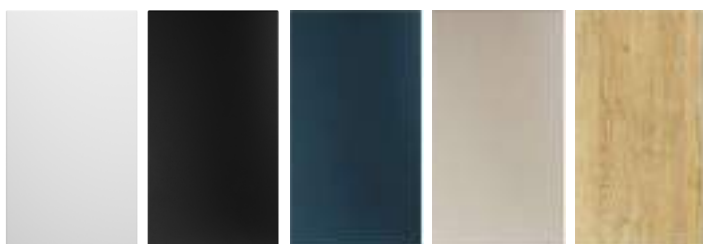

BIAŁY GROSZEK MAT
WHITE SEMI MATTE

CZARNY GROSZEK MAT
BLACK SEMI MATTE

GRANATOWY MAT
NAVY MATTE

COFFE MAT
COFFEE MATTE

DĄB LONDON
LONDON OAK

EMILY

MDF FOLIA 16 MM
MDF FOIL 16 MM



BIAŁY GROSZEK MAT
WHITE SEMI MATTE

SZARY DUST GREY MAT
DUST GREY MATTE

ZIELONY MAT
GREEN MATTE

CZARNY GROSZEK MAT
BLACH SEMI MATTE

IRMA

MDF FOLIA 19 MM
MDF FOIL 19 MM



BIAŁY GROSZEK MAT
WHITE SEMI MATTE

JASNY SZARY MAT
LIGHT GREY MATTE

ZIELONY MAT
GREEN MATTE

COFFE MAT
COFFEE MATTE

KATE

MDF FOLIA 16 MM
MDF FOIL 16 MM

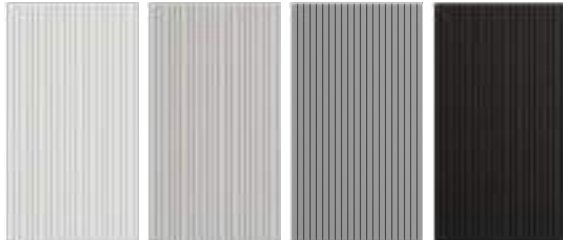

BIAŁY GROSZEK MAT
WHITE SEMI MATTE

JASNO SZARY MAT
LIGHT GREY MATTE

SZARY DUST GREY MAT
DUST GREY MATTE

CZARNY GROSZEK MAT
BLACK SEMI MATTE

LIVIA

MDF FOLIA 19 MM
MDF FOIL 19 MM



BIAŁY GROSZEK
WHITE PEAS

JASNY SZARY MAT
LIGHT GREY MATTE

TAJGA JASNA
LIGHT TAIGA

GRANATOWY MAT
NAVY MATTE

MAX

MDF 19 MM
VELVET ULTRA MAT

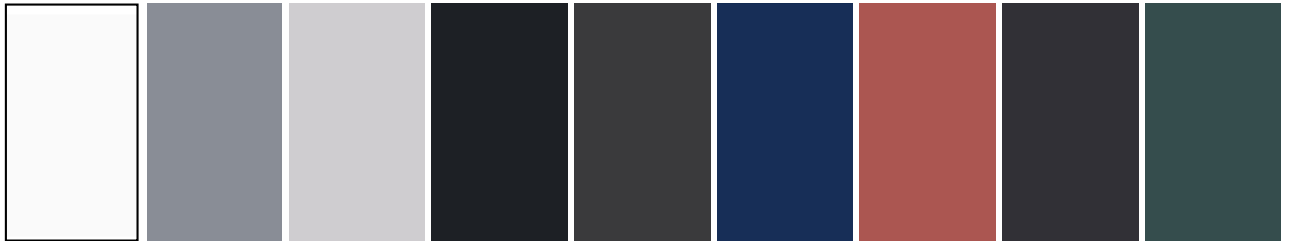

BIAŁY ALPEJSKI
ALPINE WHITE

SZARY
GREY

JASNY BĘŻOWY
LIGHT BEIGE

CZARNY
BLACK

ANTRACYTOWY
ANTRACITE

CIEMNY NIEBIESKI
DARK BLUE

CEGLASTY
BRICK RED

BRAZOWY
BRONZE

CIEMNY ZIELONY
DARK GREEN

OSCAR

MDF AKRYL 17 MM
MDF ACYLIC 17 MM



BIAŁY POŁYSK
WHITE GLOSS

ANTRACYT POŁYSK
ANTHRACITE GLOSS

Korpusy / bodies

PEYTA LAMINOWANA 16 MM
LAMINATED BOARD 16 MM

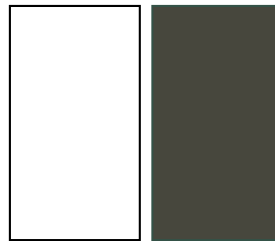

BIAŁY
WHITE

SZARY GRAFIT
GREY GRAPHITE

TRACY

MDF FOLIA PCV 16 MM
MDF FOIL PCV 16 MM

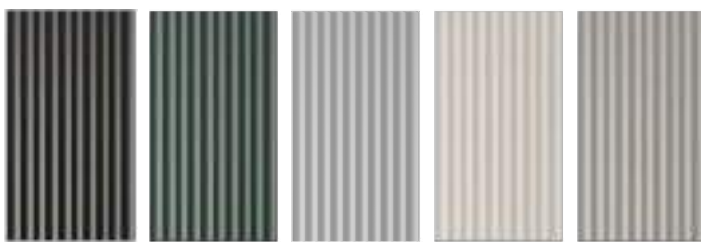

CZARNY GROSZEK MAT
BLACK SEMI MATTE

ZIELONY MAT
GREEN MATTE

SZARY DUST GREY MAT
DUST GREY MATTE

KREM MAT
CREAM MATTE

BĘŻOWY SZARY
BEIGE GRAY

ZOYA

MDF FOLIA 19 MM
MDF FOIL 19 MM



CZARNY GROSZEK MAT
BLACK SEMI MATTE

BIAŁY GROSZEK MAT
WHITE SEMI MATTE

JASNY SZARY MAT
LIGHT GRAY MATTE

DĄB HALIFAX NATURALNY
HALIFAX OAK NATURAL

Szafki górne / Top cabinets

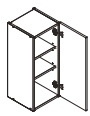

Szafka górna na wysokość 920 mm

Symbol Name	Wymiar [SxWxG] Dimension [WxHxD]
W40 P/L /92	400 x 920 x 300
W45 P/L /92	450 x 920 x 300
W60 P/L /92	600 x 920 x 300

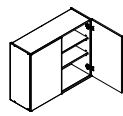

Szafka górna na wysokość 920 mm

Symbol Name	Wymiar [SxWxG] Dimension [WxHxD]
W80 /92	800 x 920 x 300

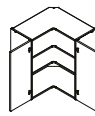

Szafka górna na wysokość 920 mm

Symbol Name	Wymiar [SxWxG] Dimension [WxHxD]
WRN P/L /92	600 x 920 x 600

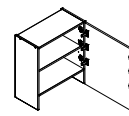

Szafka górna na wysokość 880 mm

Symbol Name	Wymiar [SxWxG] Dimension [WxHxD]
W60 SLIM P/L /88	600 x 880 x 300

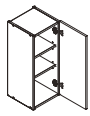

Szafka górna na wysokość 720 mm

Symbol Name	Wymiar [SxWxG] Dimension [WxHxD]
W30 P/L	300 x 720 x 300
W40 P/L	400 x 720 x 300
W45 P/L	450 x 720 x 300
W60 P/L	600 x 720 x 300

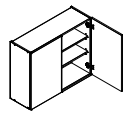

Szafka górna na wysokość 720 mm

Symbol Name	Wymiar [SxWxG] Dimension [WxHxD]
W60	600 x 720 x 300
W80	800 x 720 x 300

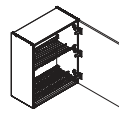

Szafka górna na wysokość 720 mm

Symbol Name	Wymiar [SxWxG] Dimension [WxHxD]
W60 SU P/L	600 x 720 x 300

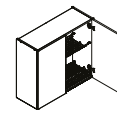

Szafka górna na wysokość 720 mm

Symbol Name	Wymiar [SxWxG] Dimension [WxHxD]
W80 SU	800 x 720 x 300

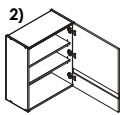

Szafka górna na wysokość 720 mm

Symbol Name	Wymiar [SxWxG] Dimension [WxHxD]
WS60 P/L	600 x 720 x 300

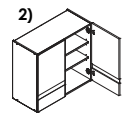

Szafka górna na wysokość 720 mm

Symbol Name	Wymiar [SxWxG] Dimension [WxHxD]
WS80	800 x 720 x 300

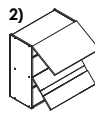

Szafka górna na wysokość 720 mm

Symbol Name	Wymiar [SxWxG] Dimension [WxHxD]
W60 GR F/2 SD	600 x 720 x 300
W80 GR F/2 SD	800 x 720 x 300

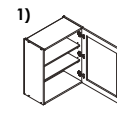

Szafka górna na wysokość 720 mm

Symbol Name	Wymiar [SxWxG] Dimension [WxHxD]
WS40 P/L	400 x 720 x 300
WS45 P/L	450 x 720 x 300
WS50 P/L	500 x 720 x 300
WS60 P/L	600 x 720 x 300

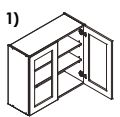

Szafka górna na wysokość 720 mm

Symbol Name	Wymiar [SxWxG] Dimension [WxHxD]
WS80	800 x 720 x 300

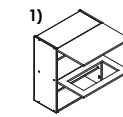

Szafka górna na wysokość 720 mm

Symbol Name	Wymiar [SxWxG] Dimension [WxHxD]
W60 GR F/2 SD	600 x 720 x 300
W80 GR F/2 SD	800 x 720 x 300

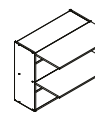

Szafka górna na wysokość 720 mm

Symbol Name	Wymiar [SxWxG] Dimension [WxHxD]
W60 GR F/2	600 x 720 x 300
W80 GR F/2	800 x 720 x 300

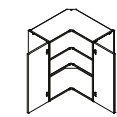

Szafka górna na wysokość 720 mm

Symbol Name	Wymiar [SxWxG] Dimension [WxHxD]
WRN P/L	600 x 720 x 600



Szafka górna na wysokość 720 mm

Symbol Name	Wymiar [SxWxG] Dimension [WxHxD]
WPO P/L	300 x 720 x 300

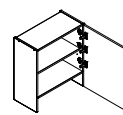

Szafka górna na wysokość 680 mm

Symbol Name	Wymiar [SxWxG] Dimension [WxHxD]
W60/68 SLIM P/L	600 x 680 x 300

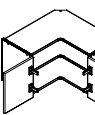

Szafka górna na wysokość 360 mm

Symbol Name	Wymiar [SxWxG] Dimension [WxHxD]
WRN/36 P/L	600 x 360 x 600

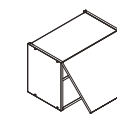

Szafka górna na wysokość 360 mm

Symbol Name	Wymiar [SxWxG] Dimension [WxHxD]
W40 OK GR	400 x 360 x 300
W50 OK GR	500 x 360 x 300
W60 OK GR	600 x 360 x 300
W80 OK GR	800 x 360 x 300
W90 OK GR	900 x 360 x 300

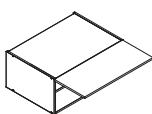

Szafka górna na wysokość 360 mm

Symbol Name	Wymiar [SxWxG] Dimension [WxHxD]
W40 OK GR	400 x 360 x 560
W50 OK GR	500 x 360 x 560
W60 OK GR	600 x 360 x 560
W80 OK GR	800 x 360 x 560
W90 OK GR	900 x 360 x 560

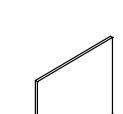

Panel boczny na wysokość 360 mm

Symbol Name	Wymiar [SxWxG] Dimension [WxHxD]
Panel boczny	564 x 360 x 19
Panel boczny	564 x 360 x 16
Panel boczny	580 x 360 x 19
Panel boczny	577 x 360 x 16

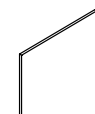

Panel boczny na wysokość 720 mm

Symbol Name	Wymiar [SxWxG] Dimension [WxHxD]
Panel boczny	304 x 720 x 19
Panel boczny	304 x 720 x 16
Panel boczny	320 x 720 x 19
Panel boczny	317 x 720 x 16

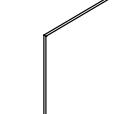

Panel boczny na wysokość 920 mm

Symbol Name	Wymiar [SxWxG] Dimension [WxHxD]
Panel boczny	304 x 920 x 19
Panel boczny	304 x 920 x 16
Panel boczny	320 x 920 x 19
Panel boczny	317 x 920 x 16

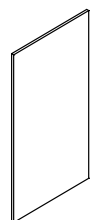

Panel boczny na wysokość 1080 mm

Symbol Name	Wymiar [SxWxG] Dimension [WxHxD]
Panel boczny	304 x 1080 x 19
Panel boczny	304 x 1080 x 16
Panel boczny	320 x 1080 x 19
Panel boczny	317 x 1080 x 16



W ofercie okap Franke kolorze srebrnym lub czarnym
The offer includes the Franke hood in silver or black

Wymiary szafek podane są w milimetrach w kolejności: Szerokość/Wysokość/Głębokość
Cabinet dimensions in millimeters in order: Width/Height/Depth

1) Typ szafki dostępny w modelach Tracy, Adele, Zoya, Livia, Denis, Irma, Kate i Emily. Cabinet type available on Tracy, Adele, Zoya, Livia, Denis, Irma, Kate and Emily.

2) Typ szafki dostępny w modelach Bono, Max i Oscar. Cabinet type available only on Bono, Max and Oscar models.

3) Panele boczne frezowane do kuchni Tracy, Adele, Irma, Kate i Emily (typowe wymiary) - pozostałe modele bez frezu. Side panels milled for the kitchen of Tracy, Adele, Irma, Kate and Emily (typical dimensions) - other models without the cutter.

W kuchni Tracy, Adele oraz Irma: szafka DK 60 dolny front gładki wykonany z MDF 19mm; szafki dolne z szufladami S/3 front szuflady niskiej gładki wykonany z MDF 19mm; szafka D15 Cargo front gładki wykonany z MDF 19mm. In the kitchen Tracy, Adele and Irma: cabinet DK 60 lower front smooth, made of 19mm MDF; lower cabinets with drawers S / 3 low drawer front smooth, made of 19mm MDF; D15 Cargo cabinet smooth front made of 19mm MDF.

W kuchni Zoya szafka D15 Cargo front wykonany z uchwytem frezowanym po 2 stronach. In the Zoya kitchen, the D15 Cargo front cabinet is made with a milled handle on both sides. We wszystkich kuchniach fronty w szafkach D60 PC P/L, W60/68 SLIM P/L, W60/88 SLIM P/L wiercone uniwersalnie oraz dokładane zaślepki puski zawiasu. In all kitchens, fronts in D60 PC P / L, W60 / 68 SLIM P / L, W60 / 88 SLIM P / L cabinets, universally drilled and fitted hinge box caps.

Modyfikacje Modifications:

Możliwość zmiany szerokości w szafkach z 1 frontem (P/L) - zakres min. 250mm-max.650 mm, zmiana o 10mm oprócz D60 PC P/L, W60/68 SLIM P/L, W60/88 SLIM P/L. Possibility to change the width in cabinets with 1 front (R / L) - range min. 250mm-max. 650 mm, change by 10mm except for D60 PC P / L, W60 / 68 SLIM P / L, W60 / 88 SLIM P / L





Możliwość zmiany szerokości w szafkach OKGR - zakres min. 400mm - max. 900mm, zmiana o 10mm. Possibility to change the width in OKGR cabinets - range min. 400mm - max. 900mm, change by 10mm.

Możliwość zmiany szerokości w szafkach dolnych szufladami - zakres min. 400mm - max. 900mm, zmiana co 50mm. Possibility to change the width in base cabinets with drawers - range min. 400mm - max. 900mm, change by 50mm.

Brak możliwości zmiany szerokości: szafek z 2 frontami, szafek z frontami ze szkłem, słupków. It is not possible to change the width of: cabinets with drawers, cabinets with 2 fronts, cabinets with glass fronts, posts.

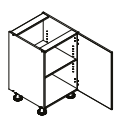
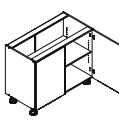
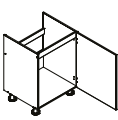
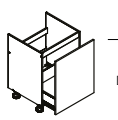
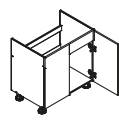
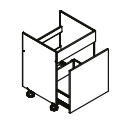
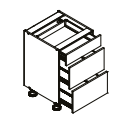
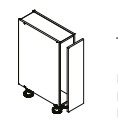
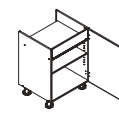
Brak możliwości zmiany głębokości i wysokości szafek. The depth and height of the cabinets cannot be changed.

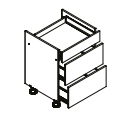
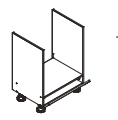
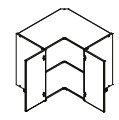
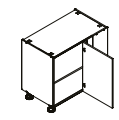
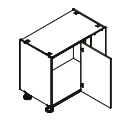
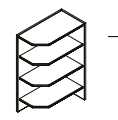
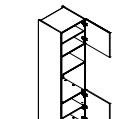
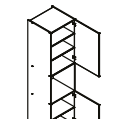
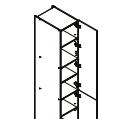
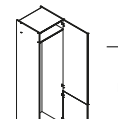
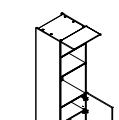
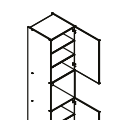
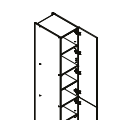
Szafki dolne / Base cabinets

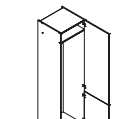
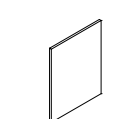
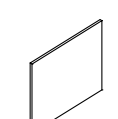
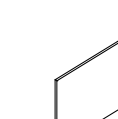
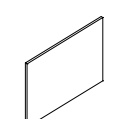
 <p>Szafka na wysokość 820 mm (wys. szafki bez blatu)</p> <p>Symbol Name Wymiar [SxWxG] Dimension [WxHxD] D30 P/L 300 x 820 x 524 D40 P/L 400 x 820 x 524 D45 P/L 450 x 820 x 524 D60 P/L 600 x 820 x 524</p>	 <p>Szafka na wysokość 820 mm (wys. szafki bez blatu)</p> <p>Symbol Name Wymiar [SxWxG] Dimension [WxHxD] D60 600 x 820 x 524 D80 800 x 820 x 524</p>	 <p>Szafka na wysokość 820 mm (wys. szafki bez blatu)</p> <p>Symbol Name Wymiar [SxWxG] Dimension [WxHxD] D60 ZL P/L 600 x 820 x 524</p>	 <p>Szafka na wysokość 820 mm (wys. szafki bez blatu)</p> <p>Symbol Name Wymiar [SxWxG] Dimension [WxHxD] D60 ZL S/I 600 x 820 x 524</p>
 <p>Szafka na wysokość 820 mm (wys. szafki bez blatu)</p> <p>Symbol Name Wymiar [SxWxG] Dimension [WxHxD] D80 ZL 800 x 820 x 524</p>	 <p>Szafka na wysokość 820 mm (wys. szafki bez blatu)</p> <p>Symbol Name Wymiar [SxWxG] Dimension [WxHxD] D80 ZL S/I ZAŚL. 800 x 820 x 524</p>	 <p>Szafka na wysokość 820 mm (wys. szafki bez blatu)</p> <p>Symbol Name Wymiar [SxWxG] Dimension [WxHxD] D40 S/3 400 x 820 x 524 D60 S/3 600 x 820 x 524 D80 S/3 800 x 820 x 524</p>	 <p>Szafka na wysokość 820 mm (wys. szafki bez blatu)</p> <p>Symbol Name Wymiar [SxWxG] Dimension [WxHxD] D15 CARGO 150 x 820 x 524 D20 CARGO 200 x 820 x 524 D30 CARGO 300 x 820 x 524</p>
 <p>Szafka na wysokość 820 mm (wys. szafki bez blatu)</p> <p>Symbol Name Wymiar [SxWxG] Dimension [WxHxD] D60 PC P/L 600 x 820 x 524</p>	 <p>Szafka na wysokość 820 mm (wys. szafki bez blatu)</p> <p>Symbol Name Wymiar [SxWxG] Dimension [WxHxD] D60 PC S/2 ZALŚL. 600 x 820 x 524</p>	 <p>Szafka na wysokość 820 mm (wys. szafki bez blatu)</p> <p>Symbol Name Wymiar [SxWxG] Dimension [WxHxD] D90 PC S/3 900 x 820 x 524</p>	 <p>Szafka na wysokość 820 mm (wys. szafki bez blatu)</p> <p>Symbol Name Wymiar [SxWxG] Dimension [WxHxD] DK60 600 x 820 x 524</p>
 <p>Szafka na wysokość 820 mm (wys. szafki bez blatu)</p> <p>Symbol Name Wymiar [SxWxG] Dimension [WxHxD] DRP P/L *864 x 820 x 864 DRP P/L **900 x 820 x 900</p>	 <p>Szafka na wysokość 820 mm (wys. szafki bez blatu)</p> <p>Symbol Name Wymiar [SxWxG] Dimension [WxHxD] DNP P/L *900 x 820 x 524 DNP P/L **1100 x 820 x 600</p>	 <p>Szafka na wysokość 820 mm (wys. szafki bez blatu)</p> <p>Symbol Name Wymiar [SxWxG] Dimension [WxHxD] DNP KOSZ P/L *900 x 820 x 524 DNP KOSZ P/L **1100 x 820 x 600</p>	 <p>Szafka na wysokość 820 mm (wys. szafki bez blatu)</p> <p>Symbol Name Wymiar [SxWxG] Dimension [WxHxD] DPO P/L 300 x 820 x 560</p>
 <p>Szafka na wysokość 2333 mm</p> <p>Symbol Name Wymiar [SxWxG] Dimension [WxHxD] D60 PK MV P/L 600 x 2333 x 560</p>	 <p>Szafka na wysokość 2333 mm</p> <p>Symbol Name Wymiar [SxWxG] Dimension [WxHxD] D60 PK P/L 600 x 2333 x 560</p>	 <p>Szafka na wysokość 2333 mm</p> <p>Symbol Name Wymiar [SxWxG] Dimension [WxHxD] D40 ŚŁ P/L 2FR 400 x 2333 x 560 D60 ŚŁ P/L 2FR 600 x 2333 x 560</p>	 <p>Szafka na wysokość 2333 mm</p> <p>Symbol Name Wymiar [SxWxG] Dimension [WxHxD] D60 LO P/L 600 x 2333 x 560</p>
 <p>Szafka na wysokość 2133 mm</p> <p>Symbol Name Wymiar [SxWxG] Dimension [WxHxD] D60 PK MV P/L 600 x 2133 x 560</p>	 <p>Szafka na wysokość 2133 mm</p> <p>Symbol Name Wymiar [SxWxG] Dimension [WxHxD] D60 PK P/L 600 x 2133 x 560</p>	 <p>Szafka na wysokość 2133 mm</p> <p>Symbol Name Wymiar [SxWxG] Dimension [WxHxD] D40 ŚŁ P/L 2FR 400 x 2133 x 560 D60 ŚŁ P/L 2FR 600 x 2133 x 560</p>	 <p>Szafka na wysokość 2133 mm</p> <p>Symbol Name Wymiar [SxWxG] Dimension [WxHxD] D30 CARGO MAXI 2133 300 x 2133 x 560</p>
 <p>Szafka na wysokość 2133 mm</p> <p>Symbol Name Wymiar [SxWxG] Dimension [WxHxD] D60 LO P/L 600 x 2133 x 560</p>	 <p>Front zmywarki</p> <p>Symbol Name Wymiar [SxWxG] Dimension [WxHxD] FR ZM 45 PO 446 / 570 FR ZM 60 PO 596 / 570 FR ZM 45 PU 446 / 713 FR ZM 60 PU 596 / 713</p>	 <p>Dolny panel boczny na wysokość 720 mm</p> <p>Symbol Name Wymiar [SxWxG] Dimension [WxHxD] Panel boczny 564 / 720 / 16 Panel boczny 564 / 720 / 19 Panel boczny 577 / 720 / 16 Panel boczny 580 / 720 / 19</p>	 <p>Dolny panel boczny na wysokość 2033 mm</p> <p>Symbol Name Wymiar [SxWxG] Dimension [WxHxD] Panel boczny ***564 x 2033 x 19 Panel boczny ***564 x 2033 x 16 Panel boczny ***577 x 2033 x 19 Panel boczny ***580 x 2033 x 16</p>
 <p>Dolny panel boczny na wysokość 2233 mm</p> <p>Symbol Name Wymiar [SxWxG] Dimension [WxHxD] Panel boczny ***564 x 2233 x 19 Panel boczny ***564 x 2233 x 16 Panel boczny ***577 x 2233 x 19 Panel boczny ***580 x 2233 x 16</p>			

*wymiar bez blatu / without worktop

**wymiar z blatem / with worktop

***Bok o wymiarach 2033x564 jest dzielony na 2 elementy: 720 mm i 1313 mm / The 2033x564 side is divided into 2 elements: 720 mm and 1313 mm

***Bok o wymiarach 2233x564 jest dzielony na 2 elementy: 720 mm i 1513 mm / The 2233x564 side is divided into 2 elements: 720 mm and 1513 mm

WYSPY KUCHEENNE

Wyspa kuchenna to marzenie wielu z Nas, aby ułatwić wybór tej idealnej, przygotowaliśmy kilka gotowych propozycji. Każda z nich to doskonałe połączenie dodatkowego blatu roboczego, przestrzeni do przechowywania oraz miejsca do spożywania posiłków.

KITCHEN ISLANDS

A kitchen island is a dream for many of us, to make it easier to choose the perfect one, we have prepared several ready-made proposals. Each of them is the excellent combination of an additional worktop, storage space and space for eating meals.

Wyspa A

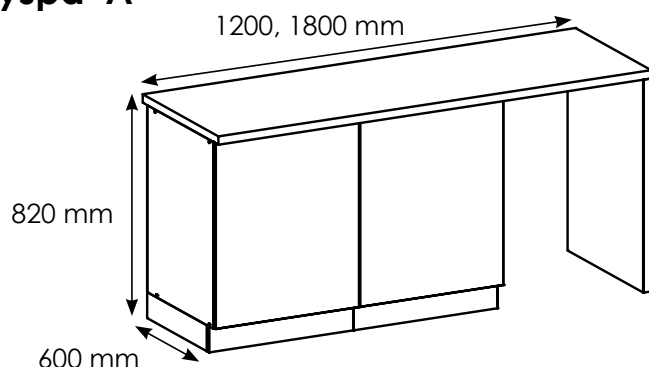

Wyspy dostępne w dwóch wariantach szerokości. The islands are available in two width variants.

Wyspa A.

I. Wariant 1200 mm*

Przykładowy skład wyspy:

1) 1x Szafka D60 + 600 mm wolnej przestrzeni na hoker

II. Wariant 1800 mm*

Przykładowy skład wyspy:

1) 2 x Szafka D60 P/L + 600 mm wolnej przestrzeni na hoker

2) 1x Szafka D80 + 1x Szafka D40 P/L + 600 mm wolnej przestrzeni na hoker

Tył wyspy wykończony formatką w kolorze frontu. Możliwość wykończenia boków wyspy bokami dokładanymi.

*Wymiar wewnętrzny wyspy, wymiar zewnętrzny należy powiększyć o grubość blatu.

Island A.

I. 1200mm variant*

Sample island composition:

1) 1x Cabinet D60 + 600 mm free space for a stool

II. 1800mm variant*

Sample island composition:

1) 2 x Cabinet D60 R/L + 600 mm free space for a stool

2) 1x Cabinet D80 + 1x Cabinet D40 R/L + 600 mm free space for a stool

The back of the island is finished with a format in the color of the front. Possibility to finish the sides of the island with added sides.

*The internal dimension of the island, the external dimension should be increased by the thickness of the tabletop.

(Depth of cabinets 580 mm + External recess 300 mm)

Wyspa B

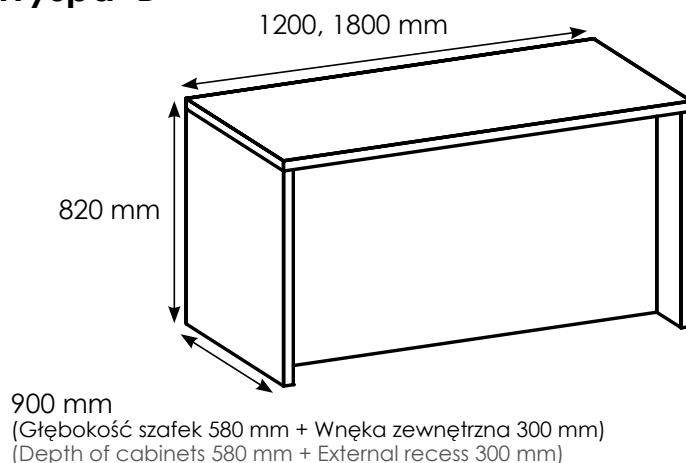

Wyspa B.

I. Wariant 1200 mm*

Przykładowy skład wyspy:

- 1) 1 x Szafka D60 P/L + 1 x Szafka D60 S/3
- 2) 1 x Szafka D80 S/3+ 1 x Szafka D40 P/L

II. Wariant 1800 mm*

Przykładowy skład wyspy:

- 1) 1 x Szafka D60 S/3 + 2 x Szafka D60 P/L
- 2) 1 x Szafka D80 + 1 x Szafka D80 S/3 + 1 x Szafka D 20 Cargo

Tył wyspy wykończony formatkami w kolorze frontu, dociętymi na szerokość szafek wchodzących w skład wyspy.

*Wymiar wewnętrzny wyspy, wymiar zewnętrzny należy powiększyć o grubość blatu.

Island B.

I. 1200mm variant*

Sample island composition:

- 1) 1 x Cabinet D60 R/L + 1 x Cabinet D60 S/3
- 2) 1 x Cabinet D80 S/3+ 1 x Cabinet D40 R/L

II. 1800mm variant*

Sample island composition:

- 1) 1 x Cabinet D60 S/3 + 2 x Cabinet D60 R/L
- 2) 1 x Cabinet D80 + 1 x Cabinet D80 S/3 + 1 x Cabinet D 20 Cargo

The back of the island is finished with formats in the color of the front, cut to the width of the cabinets that make up the island.

*The internal dimension of the island, the external dimension should be increased by tabletop thickness.

Wyspa C

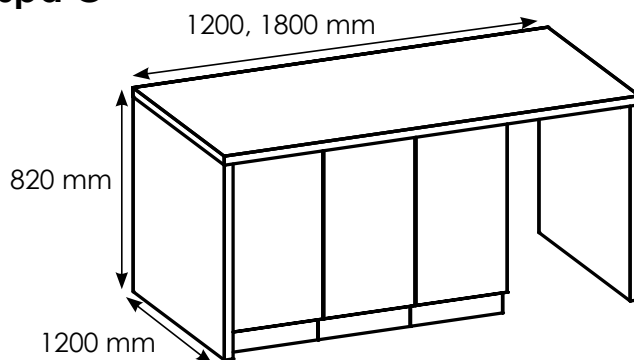

Wyspa C.

I. Wariant 1200 mm*

Przykładowy skład wyspy:

- 1) Prząd: 1x Szafka D60 + 600 mm wolnej przestrzeni na hoker
- Tył: 1x Szafka D60 + 600 mm wolnej przestrzeni na hoker

II. Wariant 1800 mm*

Przykładowy skład wyspy:

- 1) Prząd: 1x Szafka D80 + 1x Szafka D40 P/L + 600 mm wolnej przestrzeni na hoker
- Tył: 1x Szafka D80 + 1x Szafka D40 P/L + 600 mm wolnej przestrzeni na hoker
 - 2) Prząd: 1x Szafka D60 P/L + 1x Szafka D60 S/3 + 600 mm wolnej przestrzeni na hoker

Tył: 2x Szafki D60 P/L + 600 mm wolnej przestrzeni na hoker

Wewnętrzny bok wyspy wykończony formatką w kolorze frontu.

*Wymiar wewnętrzny wyspy, wymiar zewnętrzny należy powiększyć o grubość blatu.

Island C.

I. 1200mm variant*

Sample island composition:

- 1) Front: 1x Cabinet D60 + 600 mm free space for a stool
- Back: 1x Cabinet D60 + 600 mm free space for a stool

II. 1800mm variant*

Sample island composition:

- 1) Front: 1x Cabinet D80 + 1x Cabinet D40 R/L + 600 mm free space for a stool
- Back: 1x Cabinet D80 + 1x Cabinet D40 R/L + 600 mm free space on the stool
 - 2) Front: 1x D60 R/L cabinet + 1x D60 W/3 cabinet + 600 mm free space for a stool

Back: 2x Cabinets D60 R/L + 600 mm free space for a stool

The inner side of the island is finished with a format in the color of the front.

*The internal dimension of the island, the external dimension should be increased by tabletop thickness.



CLASSIC LINE

VERA
NATALIA
VITA
CLARA
EMMA
ELENA

ECO LINE

MELA



Segment mebli ekonomicznych, ale nie zabrakło tu jakości i wytrzymałości użytych materiałów. Tworzymy kompletne meble, które mają zyskać zadowolenie i satysfakcję naszych klientów.

The economic furniture segment, but there was also quality and durability of the materials used. We create complete furniture that is to gain the satisfaction of our customers.

**PROSTO I SOLIDNIE**

Komfort użytkowania gwarantują solidne i pojemne szuflady metalbox. Łatwość montażu jest ich dodatkowym atutem.

SIMPLE AND SOLID

Comfort of use is guaranteed by solid and capacious metalbox drawers. Easy assembly is their additional advantage.

**NIEOGRANICZONY DOSTĘP**

Podnośniki gazowe zapewniają swobodny dostęp do zawartości szafki.

UNLIMITED ACCESS

Gas lifts provide free access to the contents of the cabinet.

**KOMPLETNA KUCHNIA W ZASIĘGU RĘKI**

Szeroki wybór akcesoriów dodatkowych, które uprzyjemnią pracę w kuchni.

A COMPLETE KITCHEN AT YOUR FINGERTIPS

A wide selection of additional accessories that will make work in the kitchen more enjoyable.

DOBRE WYREGULOWANE*

Regulowane nóżki zapewniają stabilne ustawienie szafki nawet na nierównej powierzchni.

WELL ADJUSTED*

Assembly feet provide easy adjustment of the cabinet on uneven surfaces.

DO ZADAŃ SPECJALNYCH*

Ociekarki do naczyń to estetyczny wygląd kuchni i oszczędność miejsca.

SPECIAL TASKS*

Aluminum dish dryers are available to save space and functionality in the kitchen.

OSTATNI SZLIF

Kuchnie z systemu Eco line posiadają gotowe blaty w paczkach, docięte na wymiar szafki. W systemie Classic line, Klient może sam wybrać dowolny blat spośród 16 dostępnych dekorów.

FINAL DETAIL

Kitchens from the Eco line systems have ready worktops in packages, cut to size cabinets. In the Classic line system, the customer can choose any worktop from 16 available decors.

NAMACALNA JAKOŚĆ

Duże metalowe uchwyty - piękne i bardzo wygodne, dostępne we wszystkich kuchniach z systemu Classic line.

PALPABLE QUALITY

Large metal handles - beautiful and very comfortable, available in all kitchens from the Classic line system.

CISZA W KUCHNI

Zawiasy oraz szuflady wyposażone w system cichego domykania gwarantują delikatne zamykanie i otwieranie frontów. W szafkach o szerokości powyżej 600 mm, 3 zawiasy w standardzie.

SILENCE IN THE KITCHEN

The hinges and drawers are equipped with the soft closing system to make the front open and shut in a delicate manner. In cabinets over 600 mm wide, 3 hinges as standard.

*Nie dotyczy systemu ECO LINE
*Does not apply ECO LINE system



VERA

dostępna kolorystyka blatów s. **117**
 wykaz dostępnych szafek s. **114-116**

available colors of cabinets, worktops p. **117**
 specification of available cabinets p. **114-116**

Meble kuchenne z frontami z płyty laminowanej
 połączonymi z frontami z płyty foliowanej MDF.

Kitchen furniture with fronts made of laminated
 board combined with fronts made of foiled MDF
 board.



metalowy uchwyt
 metal handle

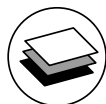

blat do wyboru
 worktop to
 choose from



Szafki i zawiasy wyposażone są
 w system cichego domykania.
 Drawers and hinges are equip-
 ped with a soft closing system.

fronty / fronts



jasny szary mat dąb wotan
 light grey matte wotan oak

korpus / body



popiel
 light grey

blat / worktop

s. **117**







NATALIA JASNY SZARY MAT



NATALIA BIAŁY POŁYSK

NATALIA

dostępna kolorystyka blatów **s. 117**
wykaz dostępnych szafek **s. 114-116**

available colors of cabinets, worktops **p. 117**
specification of available cabinets **p. 114-116**

Meble kuchenne z foliowanymi, frezowanymi frontami z płyty MDF.

Kitchen furniture with foil, milled fronts made of MDF.

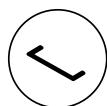

metalowy uchwyt
metal handle

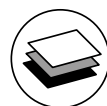

blat do wyboru
worktop to
choose from



Szafki i zawiasy wyposażone są
w system cichego domykania.
Drawers and hinges are equip-
ped with a soft closing system.

fronty / fronts



biały połysk
white high gloss



jasny szary mat
light grey mat

szkło / glass



satynato
milky

korpus / body



popiel
light grey

blat / worktop

s. 117



VITA

dostępna kolorystyka blatów s. **117**
wykaz dostępnych szafek s. **114-116**

available colors of cabinets, worktops p. **117**
specification of available cabinets p. **114-116**

Meble kuchenne z frontami w wysokim połysku wykonane z płyty akrylowej.

Kitchen furniture with high gloss fronts made of acrylic board.



metalowy uchwyt
metal handle

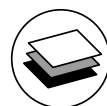

blat do wyboru
worktop to
choose from



Szafki i zawiasy wyposażone są w system cichego domykania. Drawers and hinges are equipped with a soft closing system.

fronty / fronts



biały akryl połysk
white acrylic gloss

szkło / glass



satinato
milky

korpus / body



biały
white

blat / worktop

s. **117**

CLARA

dostępna kolorystyka blatów **s. 117**
 wykaz dostępnych szafek **s. 114-116**

available colors of cabinets, worktops **p. 117**
 specification of available cabinets **p. 114-116**

Meble kuchenne z frontami z płyty laminowanej w dekorze szary grafit oraz dąb artisan.

Kitchen furniture with laminated board fronts in grey graphite and artisan oak decors.



metalowy uchwyt
metal handle

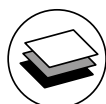

blat do wyboru
worktop to
choose from



Szafki i zawiasy wyposażone są w system cichego domykania. Drawers and hinges are equipped with a soft closing system.

fronty / fronts



szary grafit
grey graphite



dąb artisan
artisan oak

korpus / body



popiel
light grey

blat / worktop
s. 117







EMIMA

dostępna kolorystyka blatów **s. 117**
wykaz dostępnych szafek **s. 114-116**

available colors of cabinets, worktops **p. 117**
specification of available cabinets **p. 114-116**

Meble kuchenne z frontami z płyty laminowanej w dekorach szara patyna i dąb burlington.

Kitchen furniture with laminated board fronts in grey and burlington oak decors.

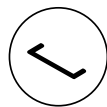

metalowy uchwyt
metal handle

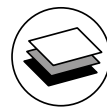

blat do wyboru
worktop to
choose from



Szafki i zawiasy wyposażone są w system cichego domykania. Drawers and hinges are equipped with a soft closing system.

fronty / fronts



dąb burlington szara patyna
burlington oak gray platinum

korpus / body



biały
white

blat / worktop

s. 117

ELENA

dostępna kolorystyka blatów **s. 117**
wykaz dostępnych szafek **s. 114-116**

available colors of cabinets, worktops **p. 117**
specification of available cabinets **p. 114-116**

Meble kuchenne z frontami z płyty laminowanej w dekorze czarny groszek oraz dąb artisan.

Kitchen furniture with laminated board fronts in black mat and artisan oak decors.



metalowy uchwyt
metal handle

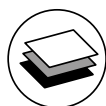

blat do wyboru
worktop to
choose from



Szufłady i zawiasy wyposażone są
w system cichego domykania.
Drawers and hinges are equip-
ped with a soft closing system.

fronty / fronts



dąb artisan
artisan oak



czarny groszek
black peas

korpus / body



biały
white

blat / worktop

s. 117







MELA BIAŁA



MELA DĄB SONOMA



MELA DĄB ARTISAN

MIELA

Zestaw mebli kuchennych z frontami z płyty laminowanej. Korpusy wykonane w kolorze frontów.

Kitchen furniture with laminated board fronts. The bodies are made in the color of the fronts.

Kuchnia sprzedawana wyłącznie w gotowych zestawach.
The kitchen is sold only in ready sets.

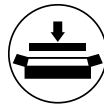

blat
w paczce
worktop
included

front i korpus / front and body



biały
white



dqb sonoma
sonoma oak



dqb artisan
artisan oak

blat / worktop



B10 Petra beż
B10 Petra beige













B26 czarna skała
B26 black rock



Lp.	Szkic szafki	Nazwa	Wymiar	Vera	Natalia	Vita	Clara	Emma	Elena
1		D80 ZL. ZAŚLEPKA	800x820x446						x
2		D80 ZL	800x820x446	x	x	x	x	x	
3		D60 S/3	600x820x446	x	x	x	x	x	x
		D40 S/3	400x820x446	x	x	x	x	x	x
4		D80 S/1	800x820x446						x
5		D80	800x820x446	x	x	x	x	x	
6		D60 ZL zaśl. P/L	600x820x446						x
7		D60 PC zaśl. P/L	600x820x446						x
8		D60 S/1 P/L	600x820x446			x			x
		D40 S/1 P/L	400x820x446			x	x		x
		D30 S/1 P/L	300x820x446						x
9		D60 P/L	600x820x446	x	x	x	x	x	
		D40 P/L	400x820x446	x	x	x	x	x	
		D30 P/L	300x820x446	x	x	x	x	x	
10		DK60	600x820x510	x	x	x	x	x	x
11		D15 CARGO	150x820x510	x	x	x	x	x	x
12		D20 CARGO	200x820x510	x	x	x	x	x	x
13		DPO P/L	300x820x560	x	x	x	x	x	x
14		DO20	200x820x446	x	x	x	x	x	x

Lp.	Szkic szafki	Nazwa	Wymiar	Vera	Natalia	Vita	Clara	Emma	Elena
15		DRP P/L	786x820x786 wymiar po blacie 900x820x900	x	x	x	x	x	x
16		DNP P/L	900x820x446 wymiar po blacie 1000x820x600	x	x	x	x	x	x
17		D40SŁ 2133 P/L	400x2133x560	x	x	x	x	x	x
18		D60PK 2133 P/L	600x2133x560	x	x	x	x	x	x
19		D60 PK MV 2133 P/L	600x2133x560	x	x	x	x	x	x
20		FRONT ZMYWARKI 60 P.Z.	596x713	x	x	x	x	x	x
21		FRONT ZMYWARKI 45 P.Z.	446x713	x	x	x	x	x	x
22		FRONT ZMYWARKI 60 P.O.	596x570	x	x	x	x	x	x
23		FRONT ZMYWARKI 45 P.O.	446x570	x	x	x	x	x	x
24		W60 PÓŁKA P/L	600x720x288					x	
25		W80	800x720x288	x	x	x	x	x	x
26		W80 SU ALU	800x720x288	x	x	x	x	x	x
27		W80 PD	800x720x288						x
28		W60 OKGR	600x360x288	x	x	x	x	x	x
		W50 OKGR	500x360x288	x	x	x	x	x	x
29		WS80	800x720x288		x				
30		WS80 SP	800x720x288				x		x

Lp.	Szkic szafki	Nazwa	Wymiar	Vera	Natalia	Vita	Clara	Emma	Elena
31		WS 80 N	800x720x288			x			
32		WS80 GRF/2 SP	800x720x288				x		x
33		W80 GRF/2	800x720x288	x				x	
34		WS80 GRF/2	800x720x288		x				
35		W60 P/L	600x720x288	x	x	x	x	x	x
		W45 P/L	450x720x288	x	x	x	x	x	x
		W40 P/L	400x720x288	x	x	x	x	x	x
		W30 P/L	300x720x288	x	x	x	x	x	x
36		W60 SU P/L	600x720x288	x	x	x	x	x	x
37		WPO P/L	300x720x288	x	x	x	x	x	x
38		WR P/L	600x720x600	x	x	x	x	x	x
39		WRN P/L	600x720x600	x	x	x	x	x	x
40		WO20	200x720x288	x	x	x	x	x	x

Blaty / worktops



B10 – PETRA BEŻ
PETRA BEIGE



B19 – ALUMINIUM MAT
ALUMINIUM MAT



BG23 – TRAWERTYN JASNY
TRAVERTINE LIGHT

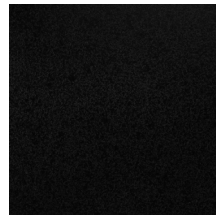

B26 – CZARNA SKAŁA
BLACK ROCK



BG30 – DĄB ARLINGTON
OAK ARLINGTON



BG31 – TIVANO
TIVANO



BG38 – DĄB LANCELOT
OAK LANCELOT



BG41 – MARMUR PIEMONTE
MARBLE PIEMONTE



BG46 – DĄB MONTANA
MONTANA OAK

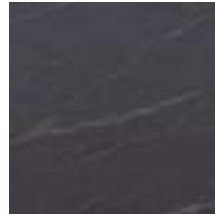

BG47 – KALLISTO
KALLISTO

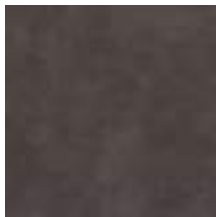

BG48 – COTOPAXI
COTOPAXI



BG49 – Hikora Naturalna
Hikora Natural

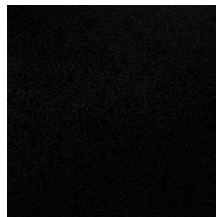

BG50 – Czarny Kamień
Black Stone



BG51 – Imperial
Imperial

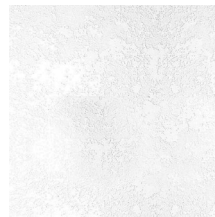

BG52 – Biały Kamień
White Stone



BG53 – Czarne Eleganckie Drewno
Black Elegant Wood

blaty wyspowe obustronne i wypełnienia międzyszafkowe
double-side worktops for kitchen islands



B10 – PETRA BEŻ
PETRA BEIGE



B19 – ALUMINIUM MAT
ALUMINIUM MAT



BG30 – DĄB ARLINGTON
OAK ARLINGTON



BG31 – TIVANO
TIVANO



BG41 – MARMUR PIEMONTE
MARBLE PIEMONTE

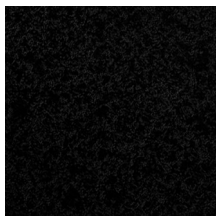

B26 – CZARNA SKAŁA
BLACK ROCK



BG46 – DĄB MONTANA
MONTANA OAK

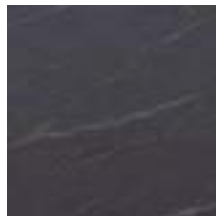

BG47 – KALLISTO
KALLISTO

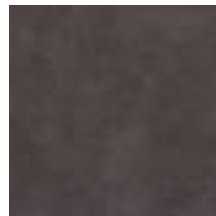

BG48 – COTOPAXI
COTOPAXI

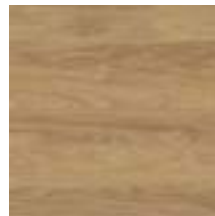

BG49 – Hikora Naturalna
Hikora Natural

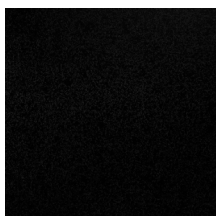

BG50 – Czarny Kamień
Black Stone



BG51 – Imperial
Imperial



BG52 – Biały Kamień
White Stone



BG53 – Czarne Eleganckie Drewno
Black Elegant Wood

B...-28mm BG...-38mm

Uchwyty / handles



inox edge bow 160
inox edge bow 160



złoty U098-160/BG r160
handle U098-160/BG r160



Uchwyt szczotkowane złoto
Brushed gold handle
2440-ZN87 R160



Uchwyt czarny mat
Mat black handle
2447-PB12 R160
2447-PB12 R320



Uchwyt złoty szczotkowany
Brushed gold handle
Paros gold 160mm
Paros gold 320mm



chrom połysk UZ-819160-UI R160
chrom połysk UZ-819320-01 R320
UZ-819160-01 R160 chrome gloss
UZ-819320-01 R320 chrome gloss



chrom inox UZ-819160-06 INOX R160
chrom inox UZ-819320-06 INOX R320
UZ-819160-06 INOX R160 chrome inox
UZ-819320-06 INOX R320 chrome inox

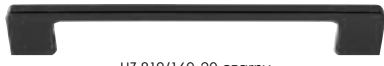

UZ 819/160-20 czarny
UZ 819/320-20 czarny
UZ 819/160-20 black
UZ 819/320-20 black



UZ 819/160-15 miedź
UZ 819 / 160-15 copper



uz 819/160-10 biały
uz 819/160-10 white



hd 180/160 inox
hd 180/160 inox



pyramid 160
pyramid 320



miedź 2318R160
miedź 2318R320
copper 2318R160
copper 2318R320



Uchwyt EDGE STRAIGHT złoty r160
EDGE STRAIGHT r160 golden handle



czarny mat EDGE STRAIGHT 76 r160
Black mat EDGE STRAIGHT 76 r160

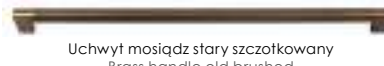

Uchwyt mosiądz stary szczotkowany
Brass handle old brushed
2457-ZN79 R160
2457- ZN79 R320

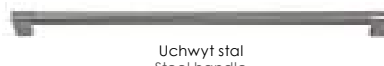

Uchwyt stal
Steel handle
2457-ZN27 R160
2457-ZN27 R320

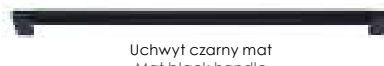

Uchwyt czarny mat
Mat black handle
2457-PB12 R160
2457-PB12 R320



Uchwyt złoty szczotkowany Lounge 21 r160
Brushed gold handle Lounge 21 r160



Uchwyt złoty połysk Lounge 29 r160
Gold gloss handle Lounge 29 r160



Uchwyt czarny mat
Mat black handle
Loft Black R160



Uchwyt srebrny stalowy Lounge r160
Silver steel handle Lounge r160



Uchwyt stalowy polerowany Lounge r160
Polished steel handle Lounge r160



chrom połysk C1515 G2 R160
C1515 G2 R160 chrome gloss



nikiel szczotkowany reling RE-10-0160-G0007 R160
RE-10-0160-G0007 R160 brushed nickel railing

Wzornik pełnej oferty uchwytów dostępny w punkcie sprzedaży.



Gałka mosiądz stary szczotkowany
Brass knob old brushed
2464-24ZN79



Gałka stal
Steel knob
2464-24ZN27



Gałka czarny mat
Black matte knob
2464-24PB12



Gałka szczotkowana Castle 31
Brushed knob Castle 31



Gałka złoty połysk Autumn 29
Golden gloss knob Autumn 29



Gałka złota Plato 31
Golden kno Plato 31



Gałka szczotkowana Point 33
Brushed knob Point 33



gałka czarna A823
black knob A823



czarny C1973/96
black C1973/96



muszelka czarna C192 P61
C192 P61 black shell



muszelka mosiądz C-192-64 R64
C-192-64 R64 brass shell



gałka mosiądz A-1043-G4
A-1043-G4 brass knob



porcelana UP190096 G00AB-MLK-2 R96
GP19-G00AB-MLK-2 porcelain knob



gałka porcelanowa GP19-G00AB-MLK-2
GP19-G00AB-MLK-2 porcelain knob



porcelana UP21-GA011-MLK-0 (rozstaw 96)
UP21-GA011-MLK-0 porcelain (spacing 96)



gałka porcelana GP19-GA011-MLK-0
GP19-GA011-MLK-0 porcelain knob



muszelka C-192 G5 R64
C-192 G5 R64 shell



gałka A1043 G49
A1043 g49 knob



*Z pasji do piękna,
potrzeby praktyczności
i komfortu w życiu codziennym
tworzymy dla Was*



Wkłady na sztućce / containers for cutlery



Wkłady na sztućce Clasico 400, 600, 800mm
[kolory: biały lub antracyt]
Flatware tray Clasico 400, 600, 800mm
[colors: white, anthracite]



Wkład na sztućce Flexi 60, 80cm
Flexi flatware tray 60, 80cm



Wkład na sztućce Heffich 40, 60, 80cm
Heffich flatware tray 40, 60, 80cm



Wkład na sztućce 40, 60, 80cm
Flatware tray 40, 60, 80cm



Maty antypoślizgowa do szuflad w formatach 400, 600, 800 mm [kolory: biały, antracyt lub kryształ]
Anti-slip mat for drawers [colors: white, anthracite or kristall]



Wkłady na sztućce Clasico 400, 600, 800mm [kolor: kryształ]
Flatware tray Clasico 400, 600, 800mm [color: kristall]



Bambusowy wkład na sztućce 400, 600, 800 mm
Bamboo cutlery insert 400, 600, 800 mm

Kosze cargo / cargo baskets



Cargo mini 150, 200, 300 mm



System Girasolo



Cargo maxi



System Duetto



Półka narożna NUVOLA
NUVOLA corner shelf



Cargo Maxi tandem 450mm, 600mm



Cargo mini boczne trzy poziomowe (150mm, 200mm)
Three level side mini Cargo (150mm, 200mm)



Cargo mini boczne na ręczniki (150mm)
Side mini Cargo for towels (150mm)



Kosz półki obrotowa 3/4
Rotating shelf basket 3/4

PURO

Kuchnia w czystej formie

The logo for REJS, featuring a stylized white geometric icon above the brand name in a bold, sans-serif font, all contained within a black rounded rectangular background.

Piękne i funkcjonalne systemy do mebli

www.e-rejs.eu

Segregacja odpadów / waste segregation



S
Pojemniki do segregacji odpadów BeEco. Moduły z pojemników 14,5L oraz 7,5L BeEco set. Modules from 14.5L and 7.5L containers



F
Obrotowy zestaw do segregacji odpadów ECO STAR 35L [3x11,7L]
Container for waste segregation



S
Pojemnik na odpady PRACTIKO 80 (Zestaw 2x15L + 2x7L)
PRACTIKO 80 [2x15L + 2x7L] container for waste segregation



S
Komplet koszy na odpady 520mm x 480mm
Set of waste containers 520mm x 480mm



F
Pojemnik do segregacji odpadów 2x16l CLEAN
Container for waste segregation 2x16l CLEAN



F
Pojemnik do segregacji odpadów wiszący 2x8L SESAMO2
hanging container for waste segregation



BIO BOY kosz podblatowy na odpady
BIO BOY under the worktop waste bin



Odbojnik PUSH OPEN
PUSH OPEN adapter

Oświetlenie / lighting



Lampka LED Square 1,5 W. Barwa ciepła lub zimna
LED Square 1.5 W lamp. Color of warm or cold



Plafond LED Look 24 V
Plafond LED Look 24 V



Zestaw oświetleniowy Quatro Led 3 punktowy. Barwa ciepła lub zimna
Quatro Led lighting set, 3 points. Warm or cold color



Oświetlenie Taśma LED 1m, 2m, 3m. Barwa ciepła lub zimna
LED Tape 1m, 2m, 3m. Warm or cold color



Zestaw oświetleniowy LED CASTELLO 3 punktowy lub 5 punktowy. Barwa ciepła lub zimna
LED CASTELLO lighting set, 3 or 5 points. Warm or cold color



Zasilacz led z włącznikiem i dystrybutorem (5 Wejść) 12v / 10w
Led power supply with Switches And distributor (5 Inputs) 12v / 10w



Obudowa LED do szafek wiszących
LED housing for hanging cabinets



Półka na metalowym stelażu 600mm lub 800mm
Open shelf cube unit 600 mm or 800 mm

Elementy dodatkowe / additional elements



Mata ochronna do szafki zlewozmywakowej 600, 800 mm.
Protective mat for the sink cabinet 600, 800 mm



Listwa przyblatowa mini. Zestaw 12 końcówek*
Mini cover strip - mounting on adhesive tape. Set of 12 ends*



Listwa montażowa
Mounting strip



Nóżka montażowa 150 mm
Mounting leg 150 mm



Uszczelka pod cokół 16, 18 mm
Sealing under the plinth 16, 18 mm



Kratka wentylacyjna pod lodówkę
Ventilation grill under the refrigerator



Skręty do blatów QUICK fi 35 (stosować min. 2szt)
Twists for QUICK tops fi 35 (use at least 2 pcs)



Półka szklana do WS 40, 50, 60, 80, 90 oraz WRS
Glass shelf to WS 40, 50, 60, 80, 90 and WRS

Zlewozmywaki / sinks



ZESTAW XL / XL SET
 GRANITOWY ZLEW (76 CM x 44 CM) + BATERIA
 Dostępne kolory:
 Zlewozmywak: beż piaskowy / czarny
 Bateria: beż piaskowy / czarny
 GRANITE SINK (76 CM x 44 CM) + BATTERY
 Available colors: sink: beige / black Battery:
 beige / black



ZESTAW L / L SET
 GRANITOWY ZLEW (59 CM x 44 CM) + BATERIA
 Dostępne kolory:
 Zlewozmywak: beż piaskowy / czarny
 Bateria: beż piaskowy / czarny
 GRANITE SINK (59 CM x 44 CM) + BATTERY
 Available colors: sink: beige / black Battery:
 beige / black



ZESTAW M LEN LUB GŁADKI SET M
 STALOWY ZLEW (79 cm x 50 cm)
 + chromowa bateria
 STEEL SINK (79 CM x 50 CM)
 + chrome battery



ZESTAW S LEN LUB GŁADKI SET M
 STALOWY ZLEW (Ø48,5 cm)
 + chromowa bateria
 STEEL SINK (Ø48,5 cm)
 + chrome battery



ZESTAW NAKŁADANY OVERLAY SINK
 dwukomorowy
 800x600 + syfon
 with double chamber
 800x600 + siphon



ZESTAW NAKŁADANY OVERLAY SINK
 jednokomorowy
 prawy lub lewy 800x600 + syfon
 with one chamber
 right or left 800x600 + siphon



AKCESORIA

Wszystko pod ręką!

ALL IN

1 szyna teleskopowa



2 bambusowa deska do krojenia

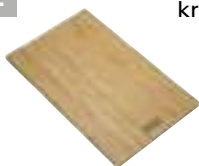

3 duża wkładka ociekowa



4 mała wkładka ociekowa

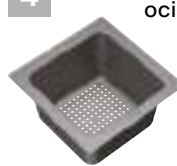

5 mały pojemnik



6 bambusowa pokrywka do małego pojemnika i wkładki



7 silikonowa mata



8 duży pojemnik



reddot winner 2022

Zaprojektowany, aby zaoszczędzić czas i miejsce

All-In to zestaw akcesoriów kuchennych, pasujący niemal do wszystkich zlewozmywaków (do szer. 540 mm). Osiem akcesoriów z nieograniczonym zastosowaniem zmienia każdy zlewozmywak w wygodne i wyjątkowo stylowe stanowisko pracy. Z All-In dostosujesz przestrzeń w kuchni idealnie do potrzeb.

SPEKTAKULARNIE DUŻY I ELEGANCKI

Zlewozmywak Maris Fraganite®. Pojemny, trwały, higieniczny.



reddot winner 2022

Wyjątkowy design i duża pojemność

Zlewozmywaki Maris Fraganite® zapewniają najwyższy komfort – tak, by gotowanie stało się przyjemnością. Pojemność i kształt komory pomagają w przygotowaniu ulubionych potraw i ułatwiają codzienną pielęgnację. Eleganckie i minimalistyczne wzornictwo pasuje do każdej aranżacji kuchennej. Szeroki wybór kolorów ułatwia dopasowanie do wymarzonej kuchni.

Elegancki czarny mat

Czerń zawsze będzie modna. W kuchni łączy ponadczasową elegancję z luksusem, tworząc harmonijną całość. Czarny kolor nadaje pomieszczeniu ciepło, tworząc przytulną przestrzeń. W ofercie Franke znajdziesz wszystkie potrzebne urządzenia i akcesoria w kolorze **czarny mat** – od zlewozmywaków i baterii kuchennych, po odpływy, przelewy, korki i osłony odpływu.

Odkryj pełną gamę modeli i kolorów komór Maris na www.franke.pl

FRANKE



płyta zintegrowana z okapem

Sam Cook to historia o pasji do gotowania.
AGD dla szukających jakości i stylu.

lodówka Multi Door



termorobot





#AGDdoZabudowy #Okapy #PiekarnikiWielofunkcyjne #NiestandardoweWymiary #Zmywarki
#PłytyGazowejElektryczne #Lodówki #Zamrażarki #Chłodziarki #KuchnieWolnostojące



Płyta indukcyjno-gazowa



Cichy i wydajny okap,
sterowany pilotem



Kompaktowy piekarnik
wielofunkcyjny

*Evolucja
szuflad*



Ten²



*Elegancki i bardzo smukły
kształt*



Ruch w najlepszym wydaniu



Omnia L

Omnia L

IMPLEMENTACJA TECHNOLOGII SLOWMOTION ULEPSZONY NOWOCZESNY DESIGN WYTRZYMAŁOŚĆ I WYSOKA SPRAWNOŚĆ PROSTY SYSTEM MONTAŻU KLIKOWEGO



IDEALNY KONCEPT WYMAGA NAJLEPSZYCH ROZWIĄZAŃ

Rozwiązania kuchenne marki Häfele to sprawdzony sposób na to, by w ergonomiczny, wygodny sposób zaplanować i zaprojektować każdą, nawet najbardziej wymagającą przestrzeń. Łącząc nowoczesną estetykę z funkcjonalnością, inteligentne i innowacyjne systemy Häfele są wsparciem dla tych, którzy w swojej pracy cenią optymalne wykorzystanie przestrzeni i konfiguracyjną swobodę aranżacji. A system oświetlenia meblowego **Loox 5** z możliwością kontroli światła z poziomu aplikacji mobilnej Häfele Connect App rzuca zupełnie nowe światło na wygodę pracy w kuchni!

**KAŻDA
PRZESTRZEŃ
PRACUJE
LEPIJ**



Szuflady Matrix S Slim

Idealnie prosty kształt boków w dwóch kontrastowych kolorach tworzy minimalistyczny design. Dzięki odchudzonym bokom o grubości 13 mm zwiększona została pojemność szuflady, a udźwieg do 35 kg daje możliwość przechowywania w niej wielu ciężkich przedmiotów.



Półka narożna Nuvola

Maksymalnie wykorzystuje przestrzeń narożnikową, a dzięki dwóm niezależnie wysuwanych półkom, daje 100% dostępności do produktów. W małej kuchni zagospodarowanie każdego wolnego miejsca jest ważne.



Fabryka Mebli Stolkar

ul. Niskie Brodno 4
87-300 Brodnica
www.stolkar.pl
stolkar@stolkar.pl

Sekretariat
tel. +48 56 49 33 510
fax. +48 56 49 33 515

Znajdź Nas na

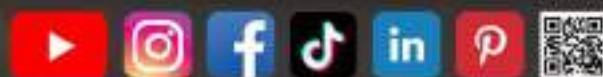

Prawa autorskie do wzoru i treści niniejszego katalogu posiada firma STOLKAR. Wszelkie kopiowanie i wykorzystywanie do własnych celów bez zgody autora jest niedozwolone. Producenci zastrzegają sobie prawo do zmian konstrukcyjnych i zmiany parametrów nie pogarszających wartości użytkowych mebli. Kolory reprodukcji w katalogu mogą odbiegać od rzeczywistych kolorów oferowanych mebli. Prezentowana oferta nie stanowi oferty w rozumieniu Kodeksu Cywilnego.

The manufacturer reserves the right to change the construction and parameters of the furniture which do not worsen its useful values. The colors reproduced in the catalog may differ from the actual colors of offered furniture. This offer is not an offer in the meaning of the Civil Code.

